

Phoenix Model# 8610

Wood Stove Heater

Explode Parts Drawing, Revision 0.0

Production dates: July 1993 - June 1995

Serial #: 000101-002189

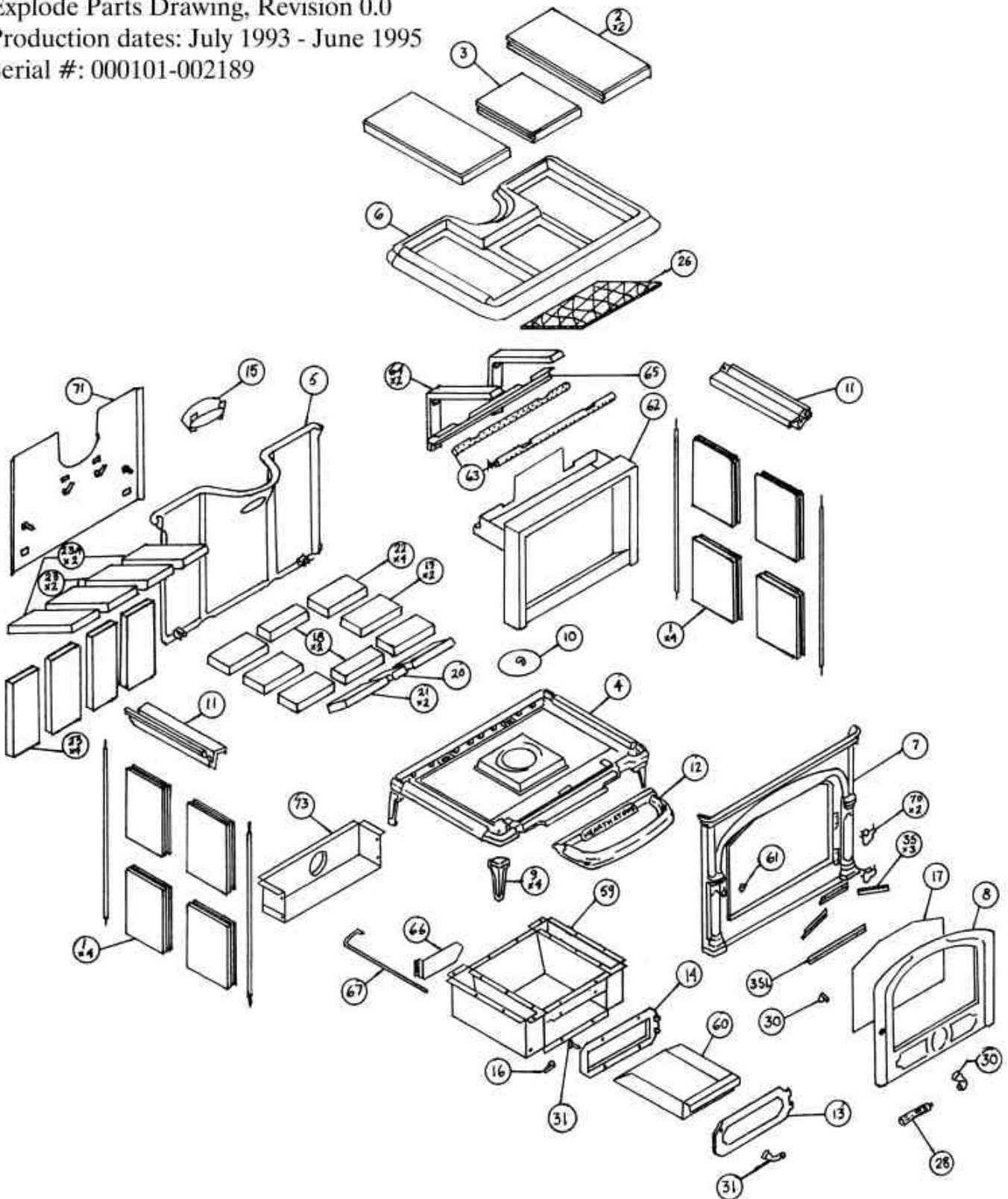



Model: Phoenix #8610

Production Dates: July 1993 - June 1995

Serial #: 000101 - 002189

Note: Color must be specified for cast iron parts which are available in enamel.

Key	Part #	Description
1	1641-301	Side Stone 9 1/2" x 7 3/4"
2	1641-302	Top Side Stone 13 7/8" x 4 7/8"
3	1641-303	Top Center Stone 11 3/8" x 8 1/4"
4	2610-001	Bottom Cast
5	2610-002	Rear Cast Panel
6	2610-003	Top Cast
7	2610-004	Front Cast Panel
8	2610-005	Front Door
9	2610-006	Leg
10	2610-008	Ash Pan Lid
11	2610-009	Side Rib
12	2610-010	Ash Lip
13	2610-011	Ash Pan Door
14	2610-012	Ash Pan Door Frame
15	2610-016	Flue Collar
16	2610-054	Air Control Handle
17	96-58605	Phoenix Glass Kit Includes: Phoenix Glass IR 10 3/8" x 15 3/4" x 5mm (4 1/3") Gasket: Tape 3/4" Adhesive Backed
18	3080-421	Bottom Center Firebrick 1.811 x 8.07 x 1.25"
19	3080-422	Bottom Side Center Firebrick 2.75 x 6.625 x 1.25"
20	3080-423	Front Center Firebrick 3.40 x .787 x 1.25"
21	3080-424	Front Side Firebrick 3.4 x 8.875 x 1.25"
22	3080-425	Bottom Side Corner Firebrick 4.437 x 6.626 x 1.25"
23	3080-426	Baffle Firebrick 4.5 x 9 1.25"
23A		Baffle Firebrick
24	96-58601	Phoenix Gasket Kit Includes:

		(2 3/4")Gasket: Rope 1/4" Black Adhesive Backed
		(4 1/2")Gasket Rope 3/8" Adhesive Backed
		(4 1/3") Gasket Tape 3/4" Adhesive Backed
		Gasket Glue
26	3120-280	Dura Blanket 1/4" 8# 2400
27	3180-080	Glass Gasket 3/4" Tape
28	90-71100	Wooden Handle Assembly
		Includes:
		Wood Handle
		1/4-20 x 3 1/4" Bolt
		(2) 1/4" Lock Washer
29	5210-3060	Threaded Rod 1/4-20 x 20 5/8" x 5/8"
30	96-73120	Front Latch Assembly 
		Includes:
		(2) Set Screw
		(4) Spacer
		Handle Crank
		Wave Spring
		Door Latch
31	96-58621	Ash Door Latch Assembly
		Includes:
		(2) Set Screw
		(4) Spacer
		Handle Crank
		Wave Spring
		Door Latch
34	5600-053	Secondary Air Clip
35	5990-129	Window Clip
49	4500-2975	Set Screw 5/16-18 x 1/4"
55	5000-008	Spline 1/8" x 3/4" x 7"
56	5000-014	Spline 1/8" x 3/4" x 10 3/4"
57	5000-020	Spline 1/8" x 3/4" x 17 5/16"
58	5800-022	Air Inlet Box
59	5800-023	Ash Pan Box
60	5800-024	Ash Pan
61	5800-030	Front Door Catch
62	5800-032	Primary Air Manifold & Baffle
63	5800-034	Stainless Steel Air Pipe
64	5800-035	Secondary Air Rise Tube
65	5800-036	Rear Baffle Support
66	5800-038	Air Control Slide

67	5800-039	Air Control Rod
70	5800-052	Front Door Hinge
71	5930-2000	Optional Rear Heat Shield
72	99-204	Rear Heat Shield Clip
73	96-56320	Optional Outside Air Kit