

Pellet Stove Service Training

Includes all pellet burning units

Manufactured by Harman Stove
Company



Objectives

- Understand the concept of air flow through a Harman pellet unit
- Understand the Harman patented feed system
- Apply knowledge to properly diagnose or troubleshoot
- Properly inform and educate consumers about pellet burning

Advance

Automatic Ignition
Room Sensor control
0 to 48,000 BTU
Gold or Bright nickel trim
Tile inserts are standard
Now cleaner glass!
Easier cleaning access
Cast Iron rear brick panel
Smoked Glass Hopper Lid



Optional Log Kit
available

P-68

Automatic Ignition
Room Sensor control
0 to 68,000 BTU
Mirrored Glass
76 Lb. Hopper capacity
Easy cleaning access



Options Include;
Brushed Stainless or
Bright Nickel Door trim
Louvers to Match
Heat Shields
Hopper Extension
Ash Door Tile Kit
Slate Tiles
3 Piece Log Set

Harman Pellet Service Training

P-61 & P-61A

8,000 to 61,000 BTU
Manual or Automatic Ignition
Room Sensor control
72 lb. Hopper Capacity



Options Include;
Brushed Stainless or
Bright Nickel Door trim
Louvers to Match
Heat Shields
Hopper Extension
Ash Door Tile Kit
Slate tiles
3 Piece Log Set

PP-38+

7,000 to 43,000 BTU
Manual Ignition Only
Thermostat Ready
50lb. Hopper Capacity



Options Include;
Gold Door
Sunrise Frame
Heat Shields
Hopper Extension
Ash Door Tile Kit
Gold Louver Trim
3 Piece Log Set

Invincible Fireplace Insert

8,000 to 53,000 BTU
Manual Ignition
Room Sensor control
40 lb. Hopper Capacity
Easy slide out design



Options Include
Brass window trim
Gold air grill plates
3 pc. Log set
Oversize and
Custom wings

Accentra Cast Iron Pellet Stove

0 to 40,000 BTU
Automatic Ignition
Quiet operation
Room sensor control
Smoked Glass Hopper Lid



Options:
Floor Protector
Leg Kit

Accentra Insert

0 to 40,000 BTU
Automatic Ignition
Room sensor control
Track system frame
57 Lb. Hopper Capacity

Options Include
2 Smaller hoppers
Wing extensions
Log set
Service rail kit
Outside air kit
Zero-clearance box
Mantles and
hearths



The XXV

0 to 50,000 BTU
Automatic Ignition
Mirrored Glass
Silent operation
Room sensor control
Highly detailed Castings
65 Lb. Hopper Capacity



Options:
Top flue conversion
25th Anniversary logo

XXV Top Flue Option

Attaches to the exhaust on the rear of the stove, and extends it to the top with a six inch stub.

This gives the appearance of a wood stove and also allows venting with existing single wall, connector. A 12 inch piece of 4" PL vent is included to act as an insulator.



PF-100 Hot Air Furnace

0 to 112,000 BTU
Automatic Ignition
Room temp control
160lb. Hopper capacity
1000 cfm blower



Options
1450 and 2000 c.f.m. blower
Outside air flex pipe
A/C relay

PC – 45 Corn Stove

0 to 45,000 BTU
Automatic Ignition
Room sensor control
Patented Pellet Feeder
Stirrer to ensure complete burn
Accordion heat exchanger
80 lb. Hopper capacity



Options Include;
Bright Nickel or
Brushed Stainless
Door Trim
Matching Louvers
Heat Shields
Hopper Extension
Ash Door Tile Kit
3 Piece Log Set
Pellet grate
Hopper Strainer



Pellet Stove Service Training

Installation Guidelines

Installation / Helpful Hints

- **Always maintain proper clearance to combustible materials**
- **Floor protection required**
- **Check with and follow local codes**
- **Check for proper power supply at wall outlet**
- **Use only approved pellet venting materials**
- **Recommended to use at least 4 feet of vertical venting whether inside or out**
- **Limit the amount of horizontal venting**
- **Always record the draft reading upon completion of installation**

Standard Venting Method

This drawing shows the recommended venting Configuration for a Harman pellet stove.

Use only approved pellet venting

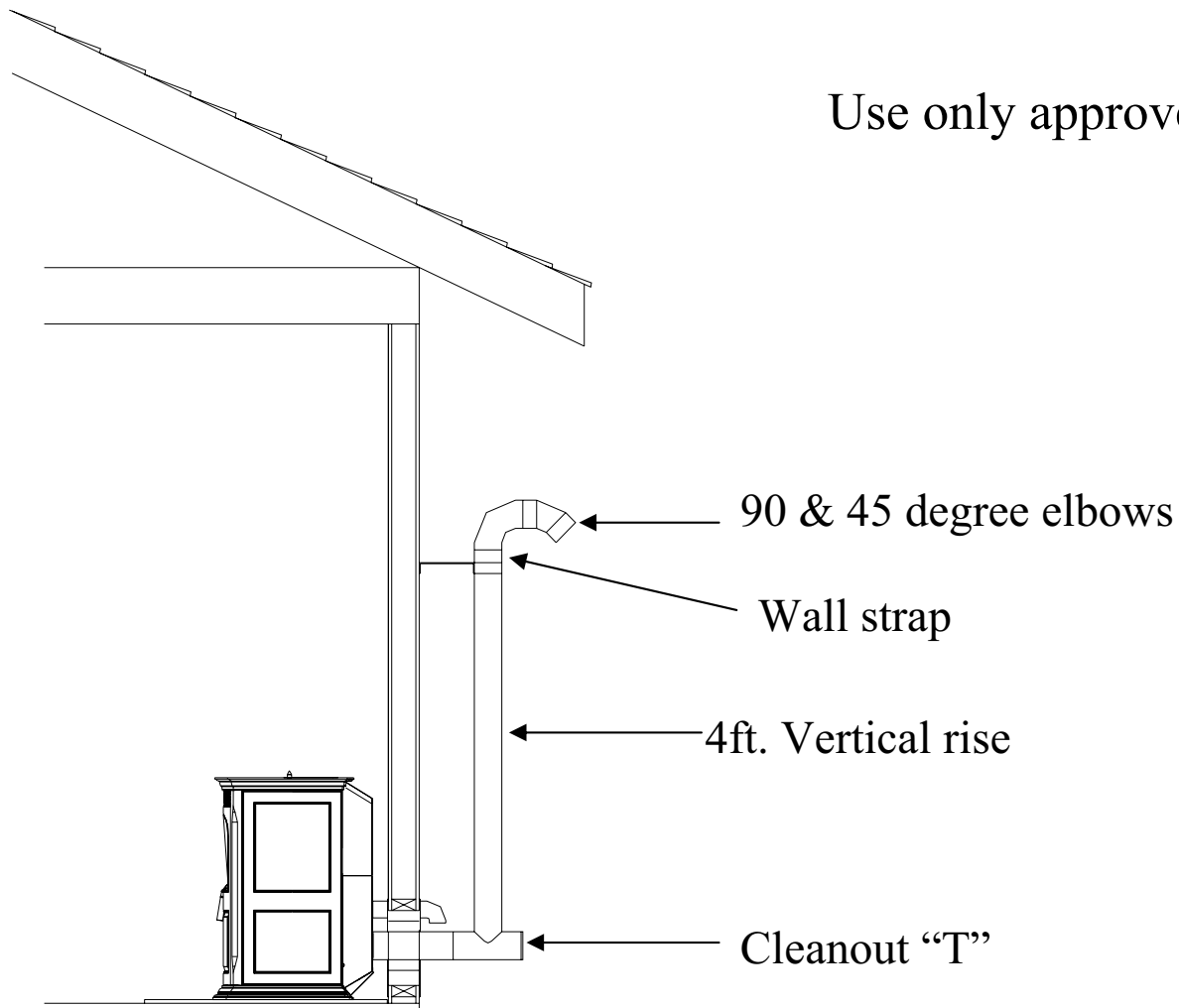

Outside Air Option

All but Invincible series can be connected to 100% outside air.

Benefits Include:

Higher efficiency

Allows termination of venting to be closer to windows or doors

Does not change air quality in the home

Outside Air Components

Rear view of stove

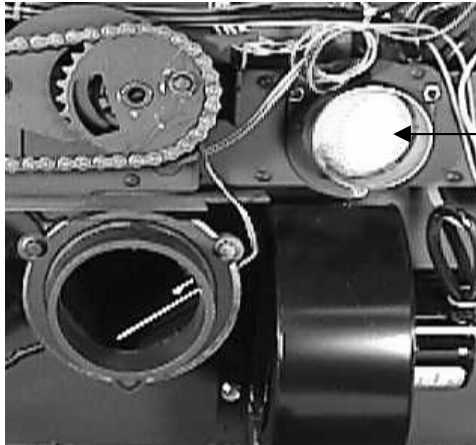

Air Intake W/ Flapper



* Outside Air Weldment
Part # 1-10-08542

* 25 ft. flex # 1-00-08543

* 3 ft. flex # 2-00-08543

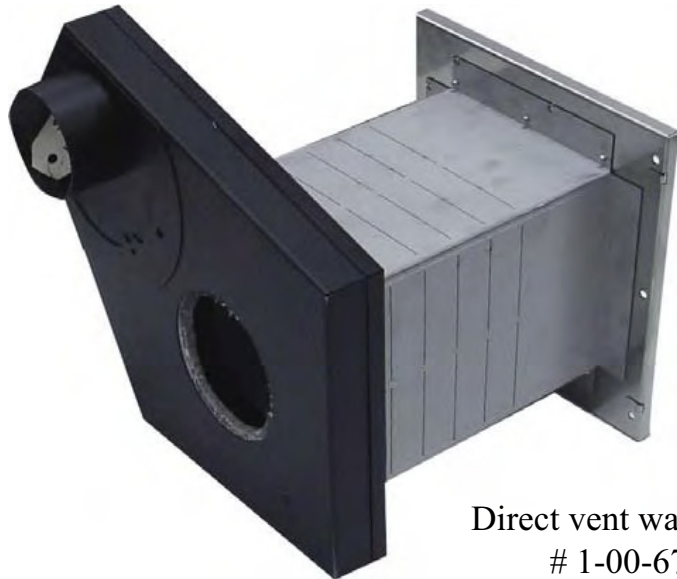

Direct vent wall pass-thru
1-00-677077



* PF100 furnace uses 2-3/4 in. flex pipe

Checking Power Supply

Wall Outlet

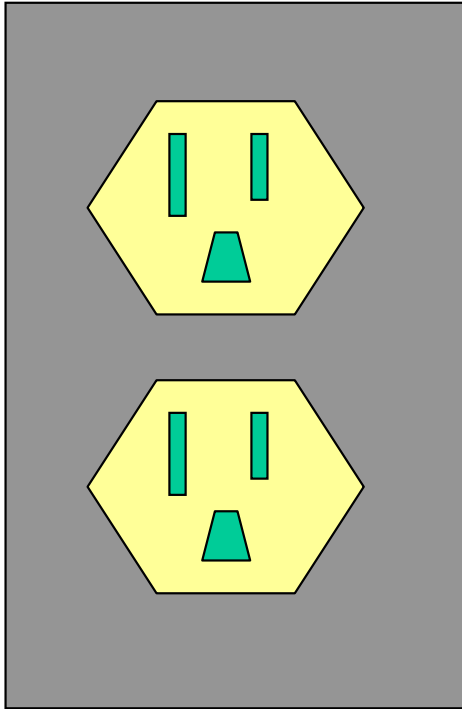

Before plugging into any outlet, be sure to test it. Proper polarity and correct voltage are of the utmost importance.

To check polarity; There are plug in testers available that simply plug in and reveal a series of lights to tell you if the polarity is correct. You can also use a volt meter to test it. Place one lead in each of the vertical slots of the outlet, you should have a reading of 112 to 122 Volts. Now place one lead in the smaller vertical slot and one lead in the rounded Ground slot.

Here you should get the same reading as you did between the two vertical slots. For the third test, place one lead in the large vertical slot and the other lead in the ground slot; you should get a reading of 0 to 10 Volts only.

Some people seem to think that an outlet is fine because their lamp and radio work fine plugged into it. That is not true. These items have a very basic Power requirement compared to the microprocessors on the Harman Circuit boards.

Surge Protection Is Recommended For All Pellet Units And required when using a Battery Back-up.



Draft Testing

All Harman pellet units have a test port on them for checking the draft. There is a draft meter kit available from Harman Stove Company, which also includes a digital multi-meter. This draft meter includes a bolt-type fitting to attach the meter to the stove.

Taking a draft reading before installing the venting will give you a reference point to shoot for after the stove is vented. Lower readings after installation indicate possible restrictions in the venting.

Item # 1-00-00637



Draft Test Procedure

For Units with “test” mode

- Remove draft test plug bolt. (9/16 wrench)
- Remove hose from draft meter
- With meter standing vertical, adjust needle to zero
- Hook up the test hose to the “low” port on the meter this is the port for measuring negative pressure
- Attach the other end of the hose to the test port on the stove using the bolt-tube fitting supplied in the kit
- Turn feed adjuster knob to “Test” All motors will run on high. Record high draft reading (.5” W.C.or more)
- After approximately 2 minutes the two blowers will begin to alternate between high and low. When the combustion blower is on low, record the low draft reading (.2”W.C.to .35” W.C.) Remember; This is negative pressure.
- Turn unit off of “test”
- Remove hose from stove port
- Replace draft test plug bolt

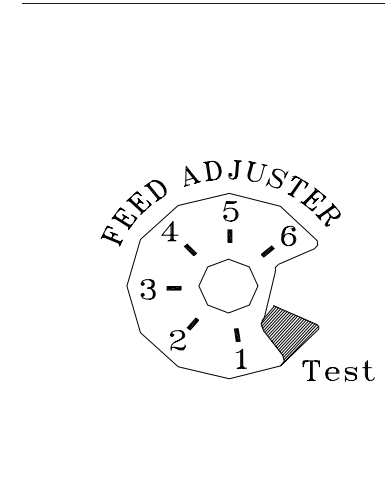

Draft Test Procedure

For PP38 +

- Remove draft test plug bolt. (9/16 wrench)
- Remove hose from draft meter
- With meter standing vertical, adjust needle to zero
- Hook up the test hose to the “low” port on the meter this is the port for measuring negative pressure
- Attach the other end of the hose to the test port on the stove using the bolt-tube fitting supplied in the kit
- Turn feed rate knob to “Turbo” All motors will run on high. Record high draft reading (.5” W.C. or more)
- Turn Feed Rate knob to #1 and allow the unit to run for about a minute, record the low draft reading (.15” W.C. to .20” W.C.)
- Adjust pot on back of circuit board if needed
- Turn Feed Rate knob to “off”
- Remove hose from stove port
- Replace draft test plug bolt

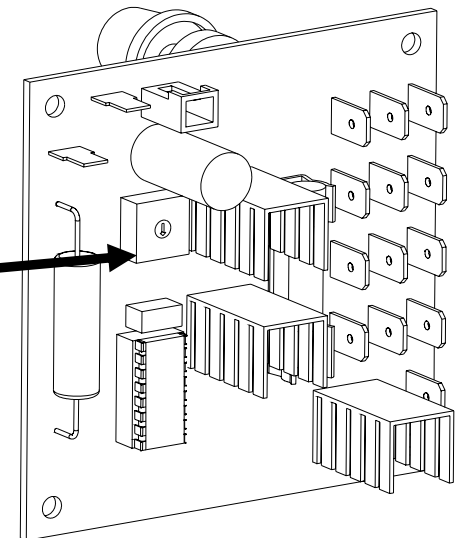
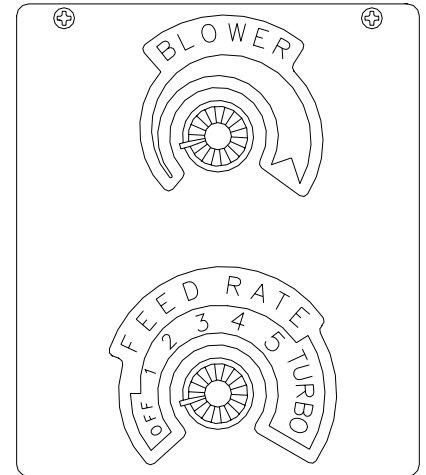

Harman Pellet Stoves



Lighting and Operation

Manual Lighting

- Connect power cord to a properly tested outlet
- Fill hopper with pellets
- Fill Burn pot with pellets
- Turn mode selector knob to “Stove Temp”
On 38+ model Turn feed rate above “2”
- Apply a generous amount of starting gel to the pellets in the burn pot
- Light the pellets in the burn pot and close the door
- Select temperature or burn rate

Auto Ignition Models

- Connect power cord to a properly tested outlet, Power light will illuminate
- Fill hopper with pellets
- Flip Toggle switch to “Auto”
- Turn mode selector knob to “Room Temp” or “Stove Temp”, Status light will come on steady
- If status light blinks refer to the blink codes in the owner’s manual
- The combustion blower and feed motor will begin to operate, At this time the igniter is also on
- Within six minutes there will be flames

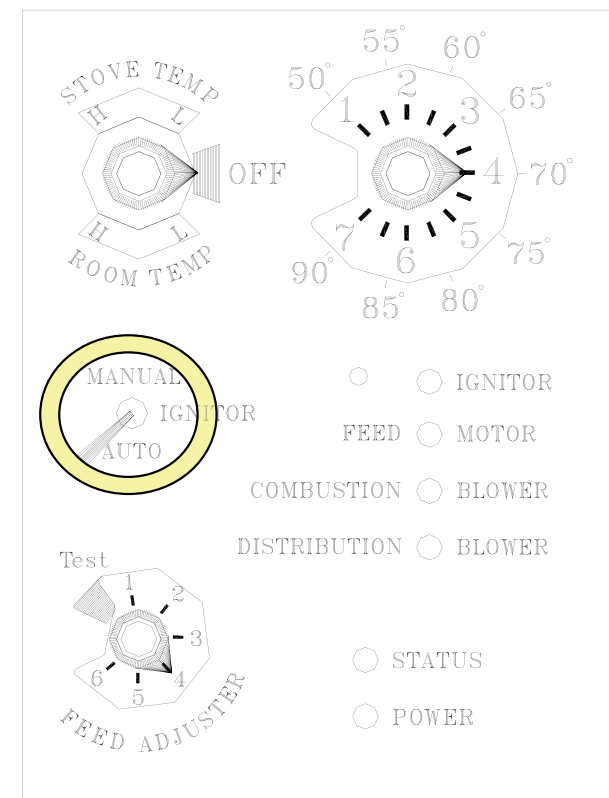

Auto-Ignition Cycle

The Ignition cycle is around a 10 minute cycle. At the beginning, the combustion blower, igniter, and feed motor all come on. After 3 to 5 minutes, the feed motor stops. Now the burn pot is loaded with fuel.

The heated air from the igniter passes through the bottom row of holes, and heats the pellets to their ignition point. As the pellets are heating up, they will produce some smoke. Now is a good time to check for leaks in the venting system! When the gases get hot enough to ignite, the smoke will change to flame and the fire is started.

As the fire burns and the exhaust temperature increases, the feed motor will run to keep the temperature increasing. When the exhaust temperature reaches around 140, the igniter will shut off.

The ESP Control

Once the fire is burning, the ESP probe, located in the exhaust, monitors the temperature and reports them to the circuit board.

The first desired temperature is 135 deg.F at 135 the feed motor is allowed to run. Next, when the temperature reaches 160 deg.F the distribution blower will begin operating. Now the circuit board knows it is not going to blow cold air into the room. The next key temperature is 210 deg. Up to this temperature, the feed motor is still limited to keep from pushing the fire out of the burn pot.

One final adjustment to be made is the feed rate. This applies to all models except the PP38+ and the PC-45. To adjust the feed rate, assure that you are in “Stove Temp” mode, and turn the temperature dial to the maximum setting. Start with the feed adjuster set on # 4, which is a maximum of 40 seconds per 1 minute cycle. Allow the stove to burn for at least 1 hour. After the hour, you’ll want to see 1 inch in front of the burning pellets. Adjust the feed adjuster up or down as needed, allow for time to settle between adjustments. Once you have it set, the only time re-adjustment would be necessary is if you change the brand of pellets being burned.

The Combustion Process

Harman pellet burners operate with a negative pressure firebox, and a positive pressure vent system. The combustion blower is positioned after and below the burn pot. It is blowing air out through the exhaust. The air that is being used for combustion comes through the air intake on the back of the stove. As the air enters the stove it is pulled through the holes in the burn pot grate and through the burning fuel. From here the heat and exhaust gases travel to the top of the stove and heat the heat exchanger surfaces. After hitting the top of the firebox, the only way left to go is down. The exhaust drops a majority of the fly-ash in the ash pan as it passes by in route to the venting system. Understanding this air flow pattern will help you to realize the importance of sealing the vent system, and measuring the draft at installation. Therefore, smelling smoke means the venting is not sealed properly.

Shut-Down Procedure

When you turn the stove to “Off”, there is a protocol programmed into the circuit board which will not allow the combustion blower to just stop. Upon turning the stove to off, the only change is that the feed motor will only run for about 7 seconds per minute. The combustion blower will also slow down to help the fire to cool. When the fire cools to a exhaust temperature of about 260 deg.F. The feed motor will shut off.

When, the exhaust temperature cools to around 90 deg., the combustion blower will shut off.

Note: The PC-45 will continue to run the combustion blower for five hours after the ESP probe cools. Also upon power-up, the combustion blower will run for one minute, If turned to on, and back off during that first minute, the combustion blower will run for the five hours.

Wiring Diagram (applies to all automatic stoves)

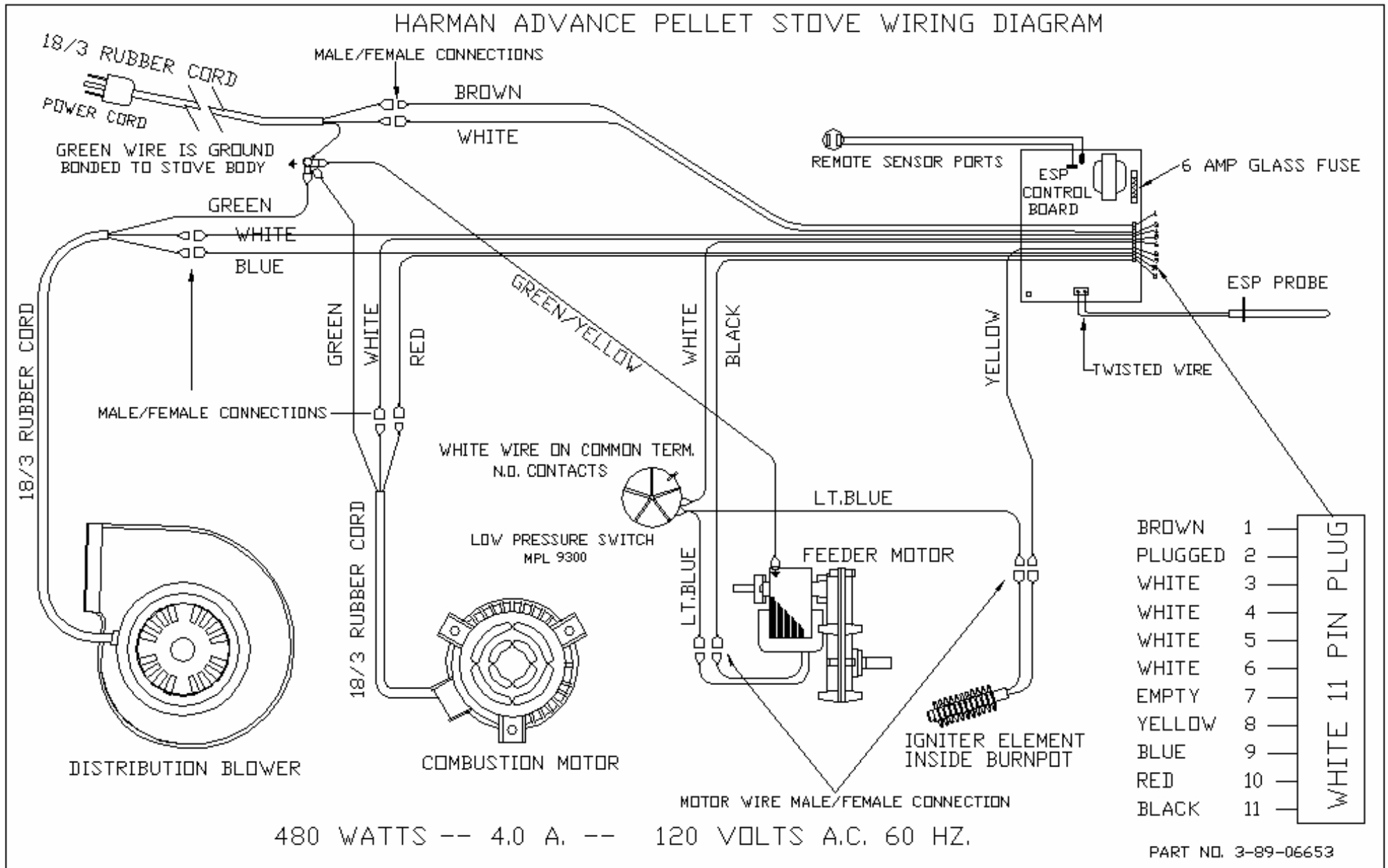

Incoming Power Circuit

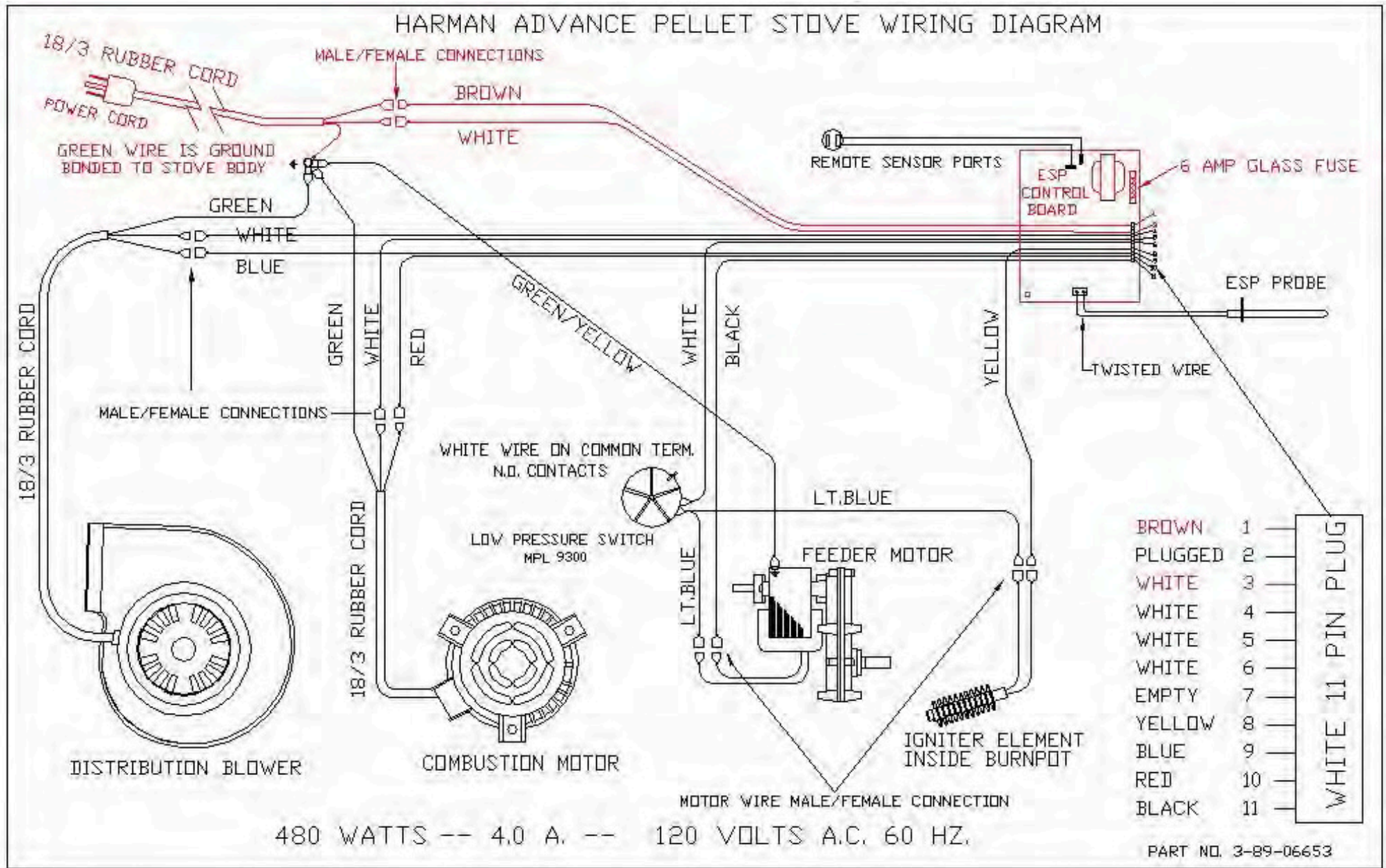

Combustion Blower Circuit

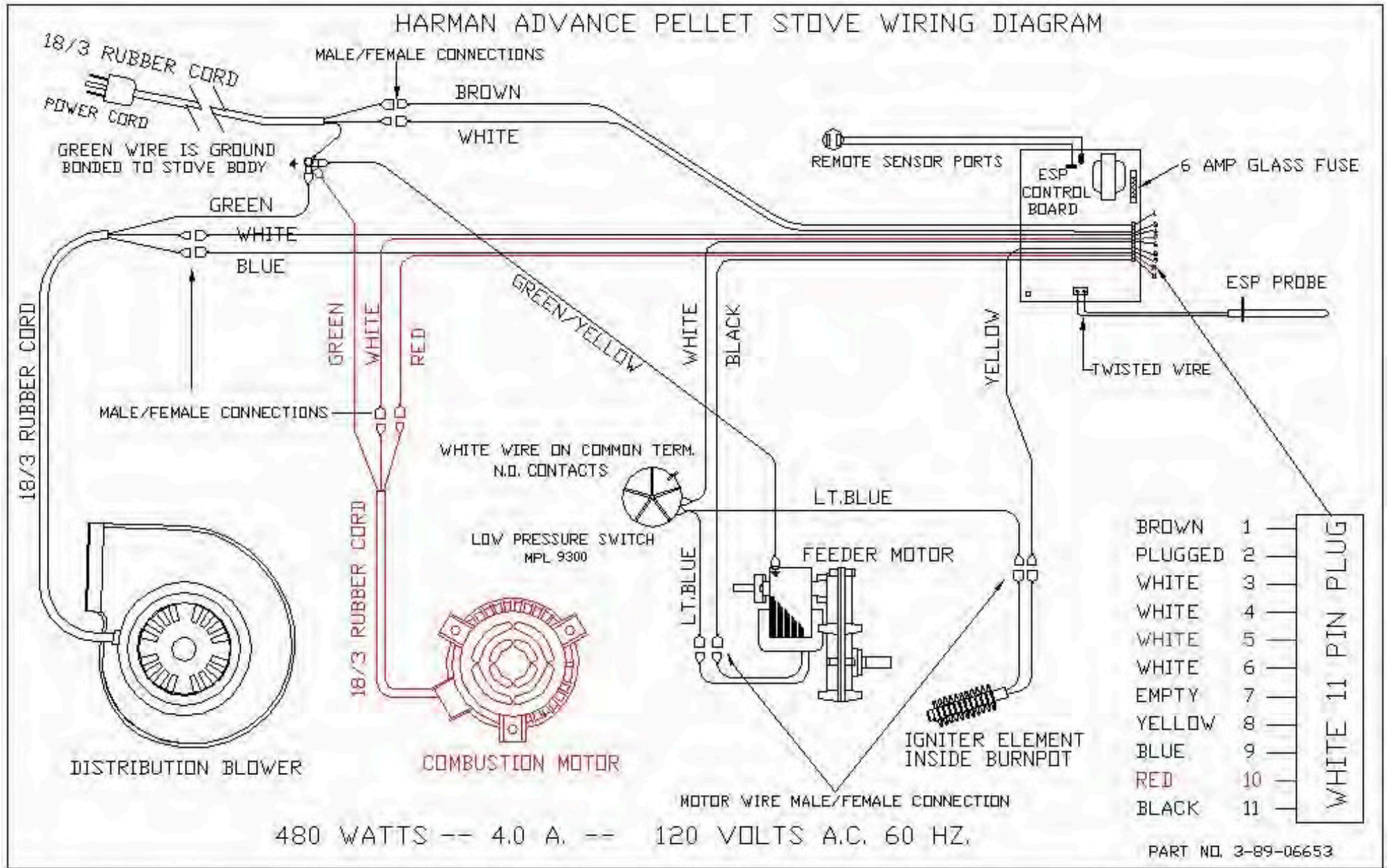

Distribution Blower Circuit

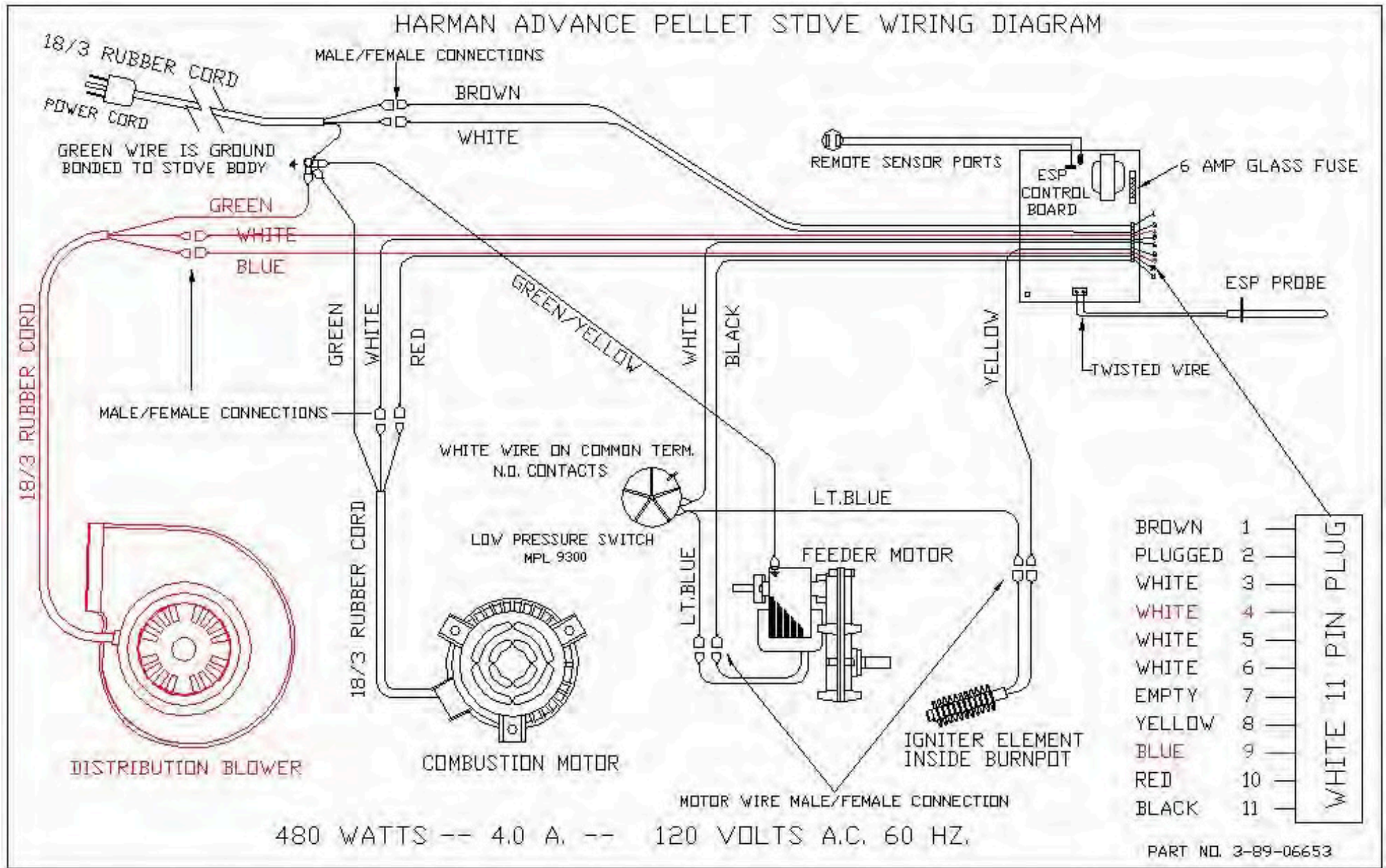

Feed Motor Circuit

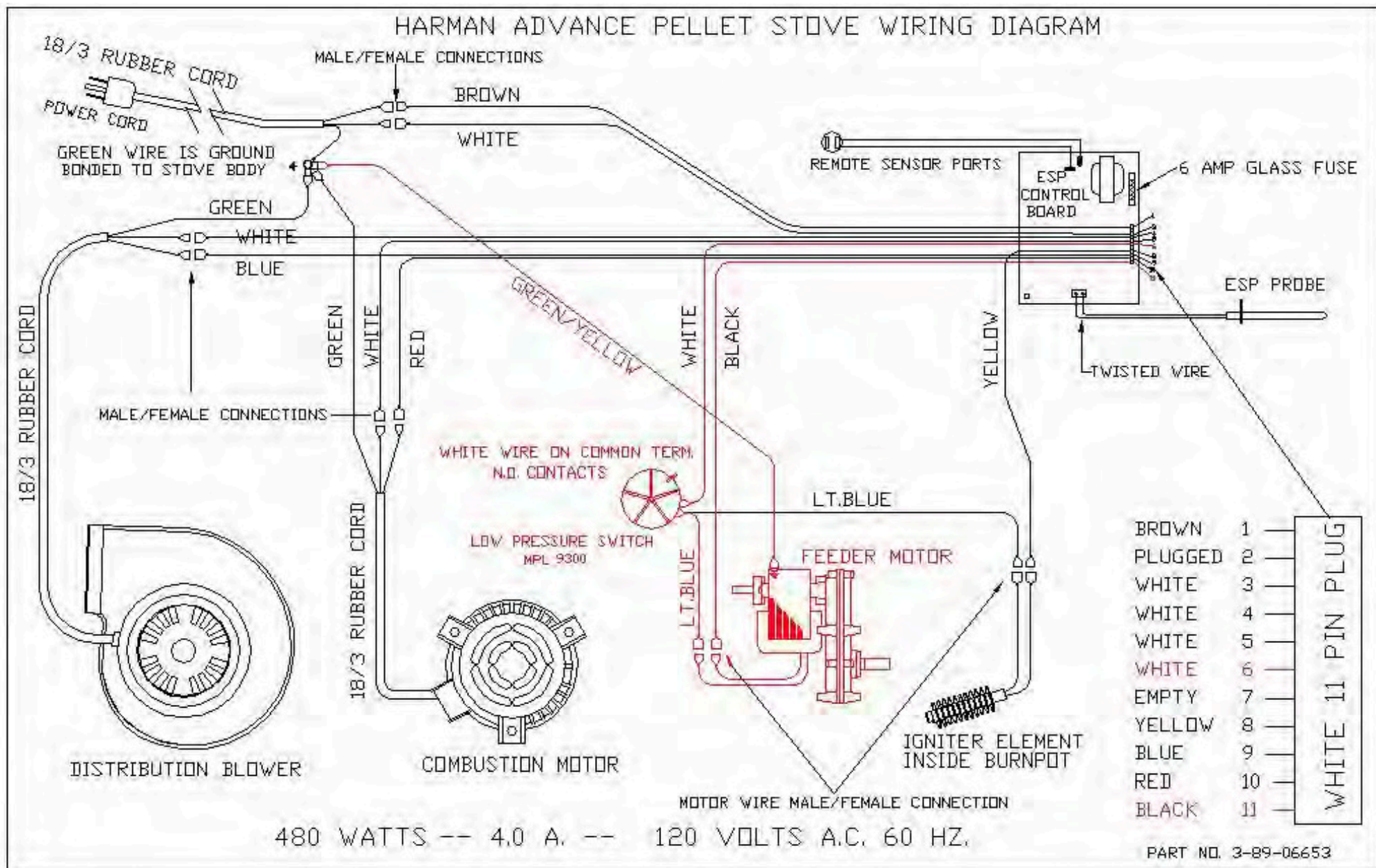

Igniter Circuit

HARMAN ADVANCE PELLET STOVE WIRING DIAGRAM

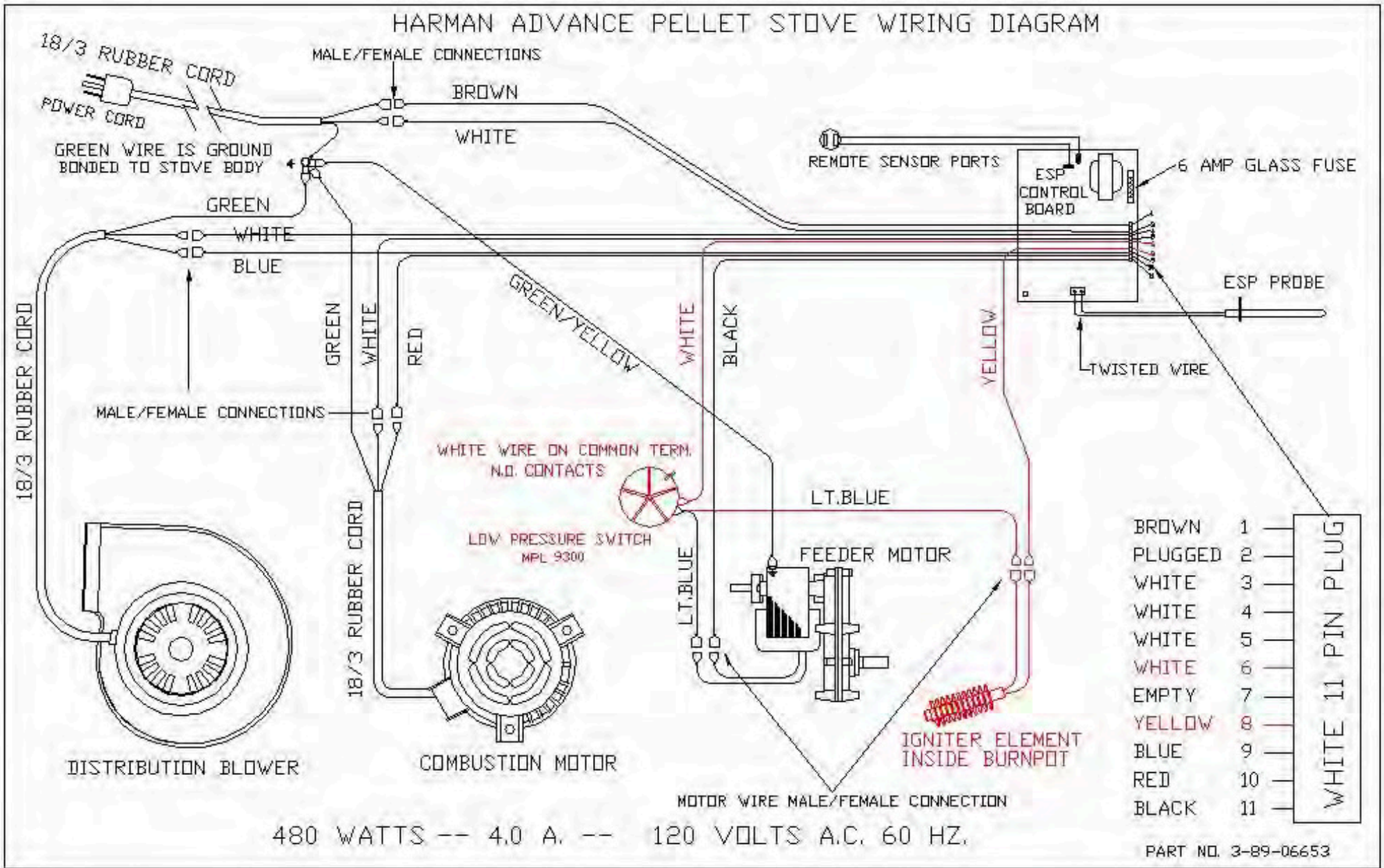

PF-100 Wiring Diagram

HARMAN PF100 PELLET FURNACE WIRING DIAGRAM

120 VOLTS A.C. 60 HZ.

1200 WATTS- 10 AMPS MAX (test mode)

900 WATTS- 7.5 AMPS NORMAL OPERATION

HIGH VOLTAGE

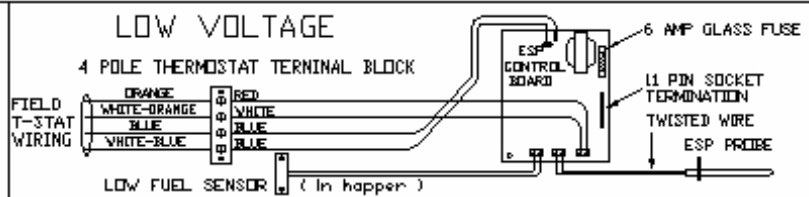
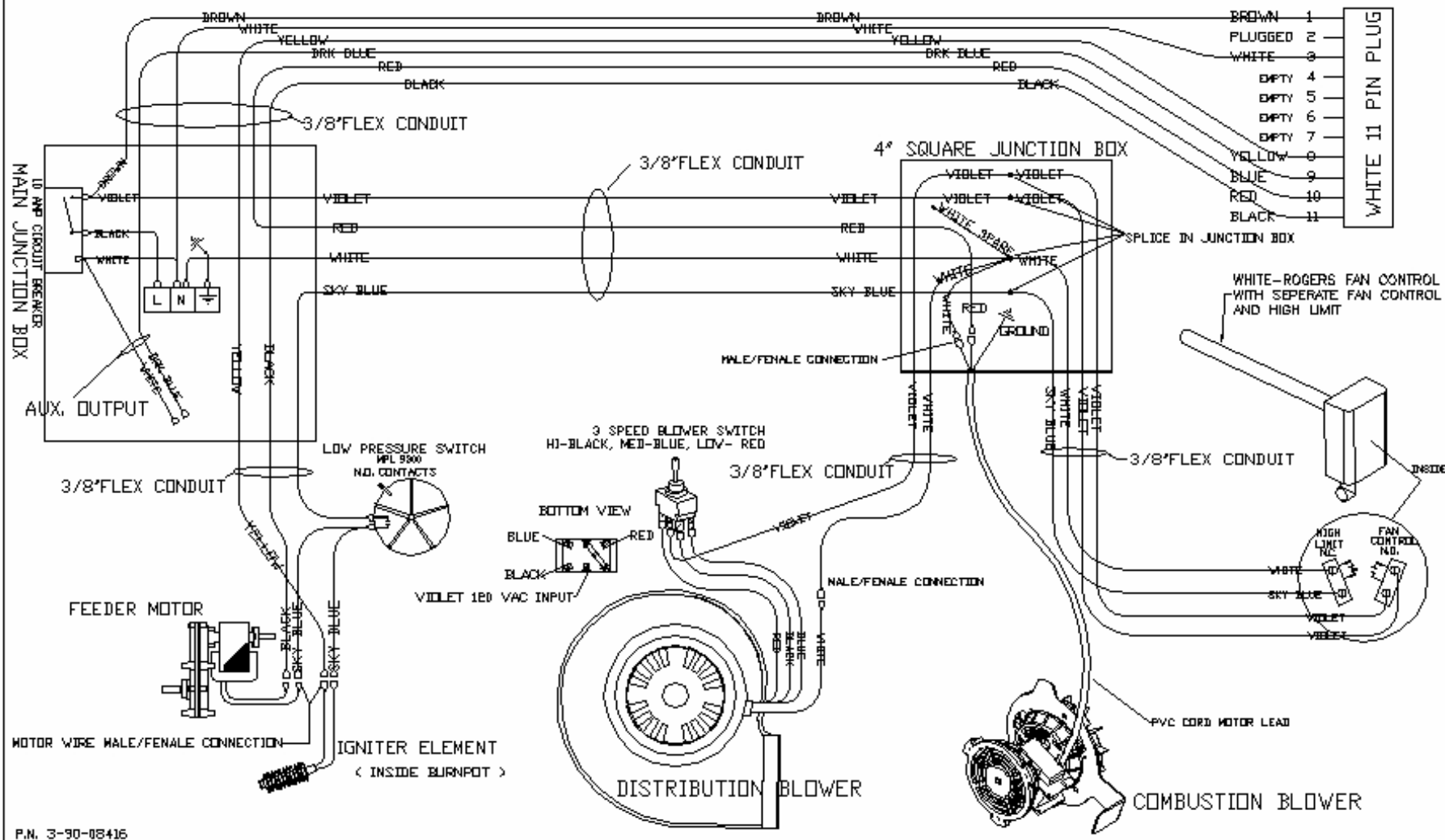

P.N. 3-90-08416

PF-100 Incoming Power Circuit

HARMAN PF100 PELLET FURNACE WIRING DIAGRAM

120 VOLTS A.C. 60 HZ.
 1200 WATTS-10 AMPS MAX (test mode)
 900 WATTS-7.5 AMPS NORMAL OPERATION

HIGH VOLTAGE

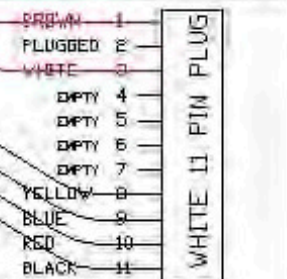
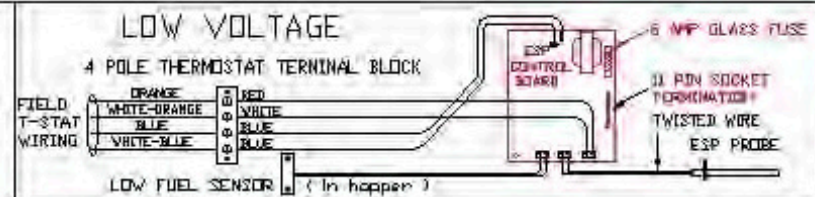
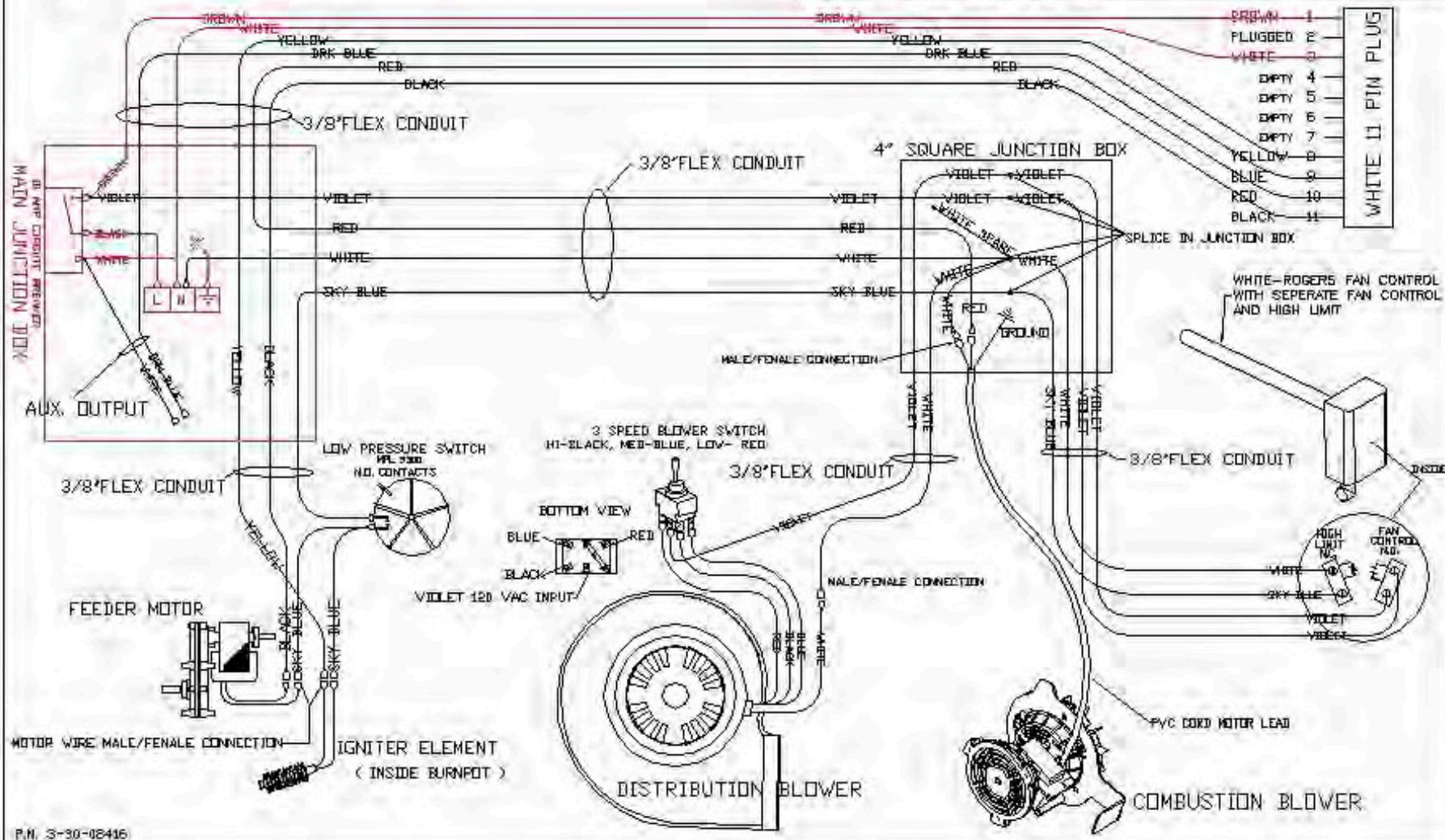

P.N. 3-30-08416

PF-100 Thermostat Control Circuit

HARMAN PF100 PELLET FURNACE WIRING DIAGRAM

120 VOLTS A.C. 60 HZ.
 1200 WATTS-10 AMPS MAX (test mode)
 900 WATTS-7.5 AMPS NORMAL OPERATION

HIGH VOLTAGE

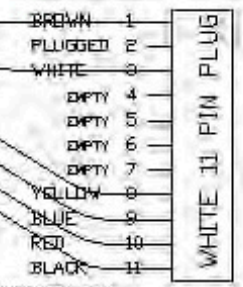
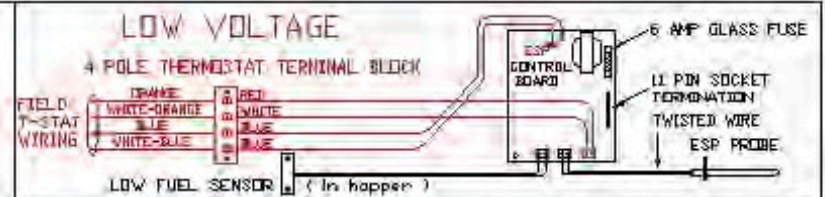
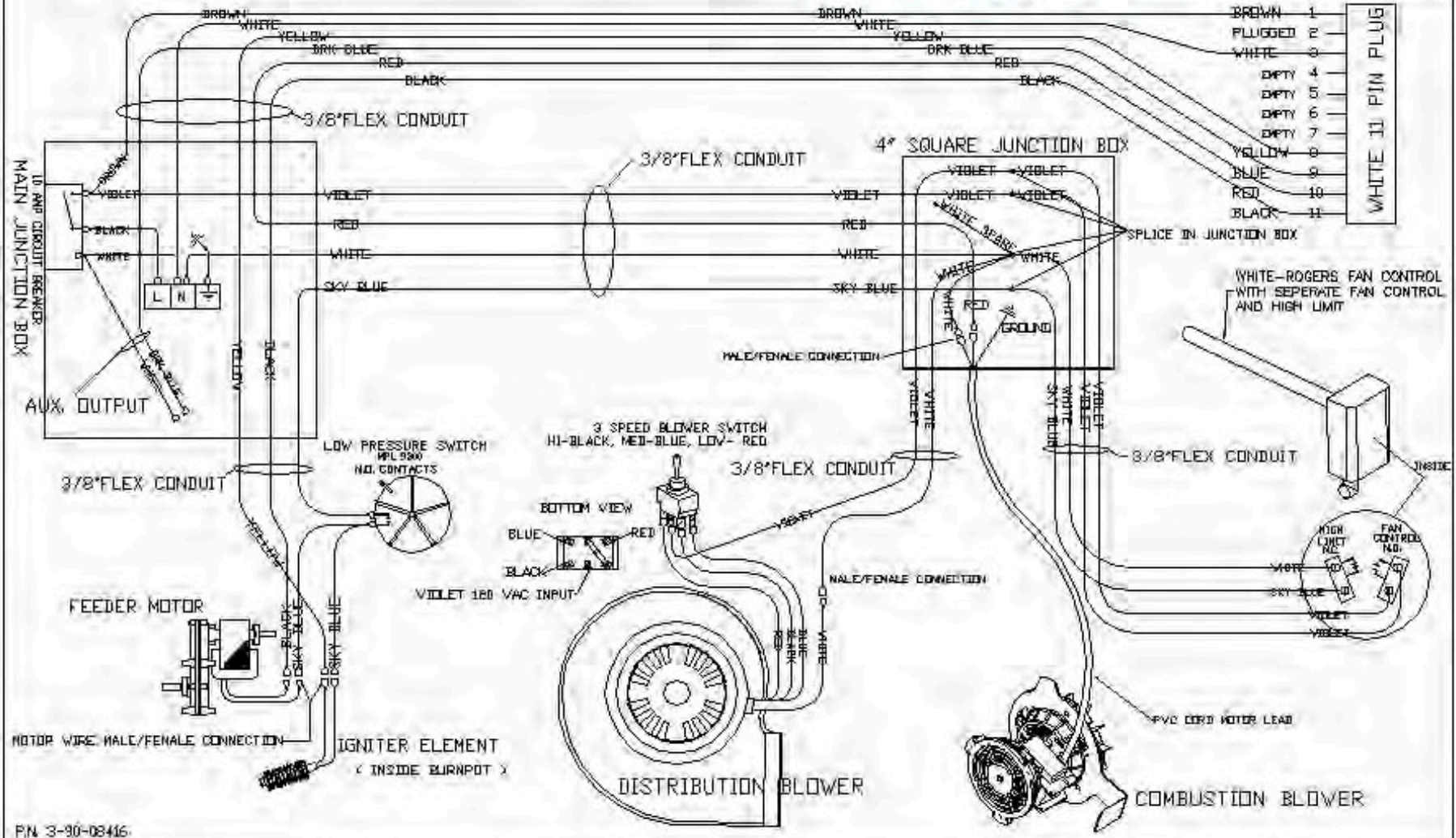

PN 3-90-08416

PF-100 Combustion Blower Circuit

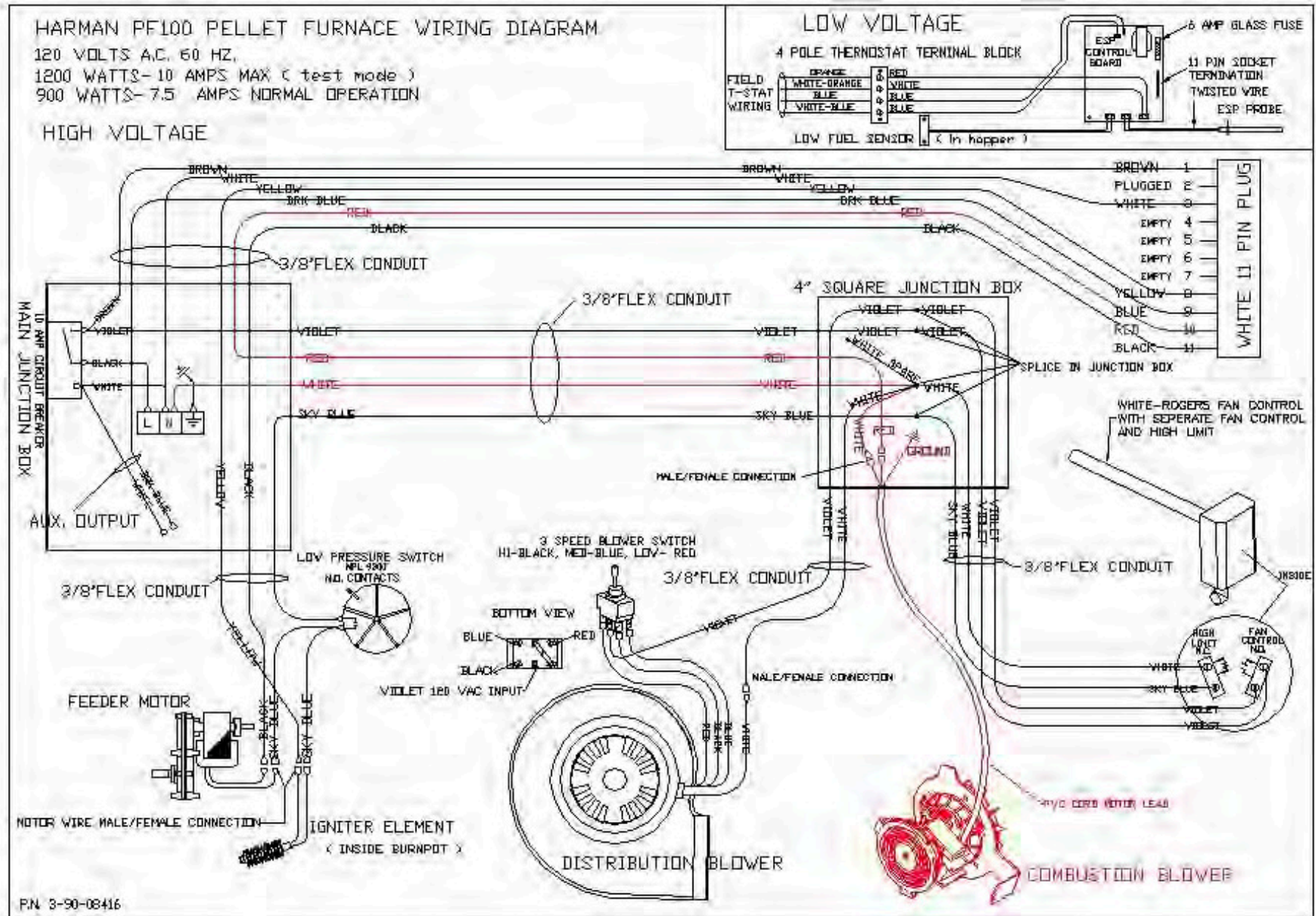

PF-100 Distribution Blower Circuit

HARMAN PF100 PELLET FURNACE WIRING DIAGRAM

120 VOLTS A.C. 60 HZ.
 1200 WATTS- 10 AMPS MAX (test mode)
 900 WATTS- 7.5 AMPS NORMAL OPERATION

HIGH VOLTAGE

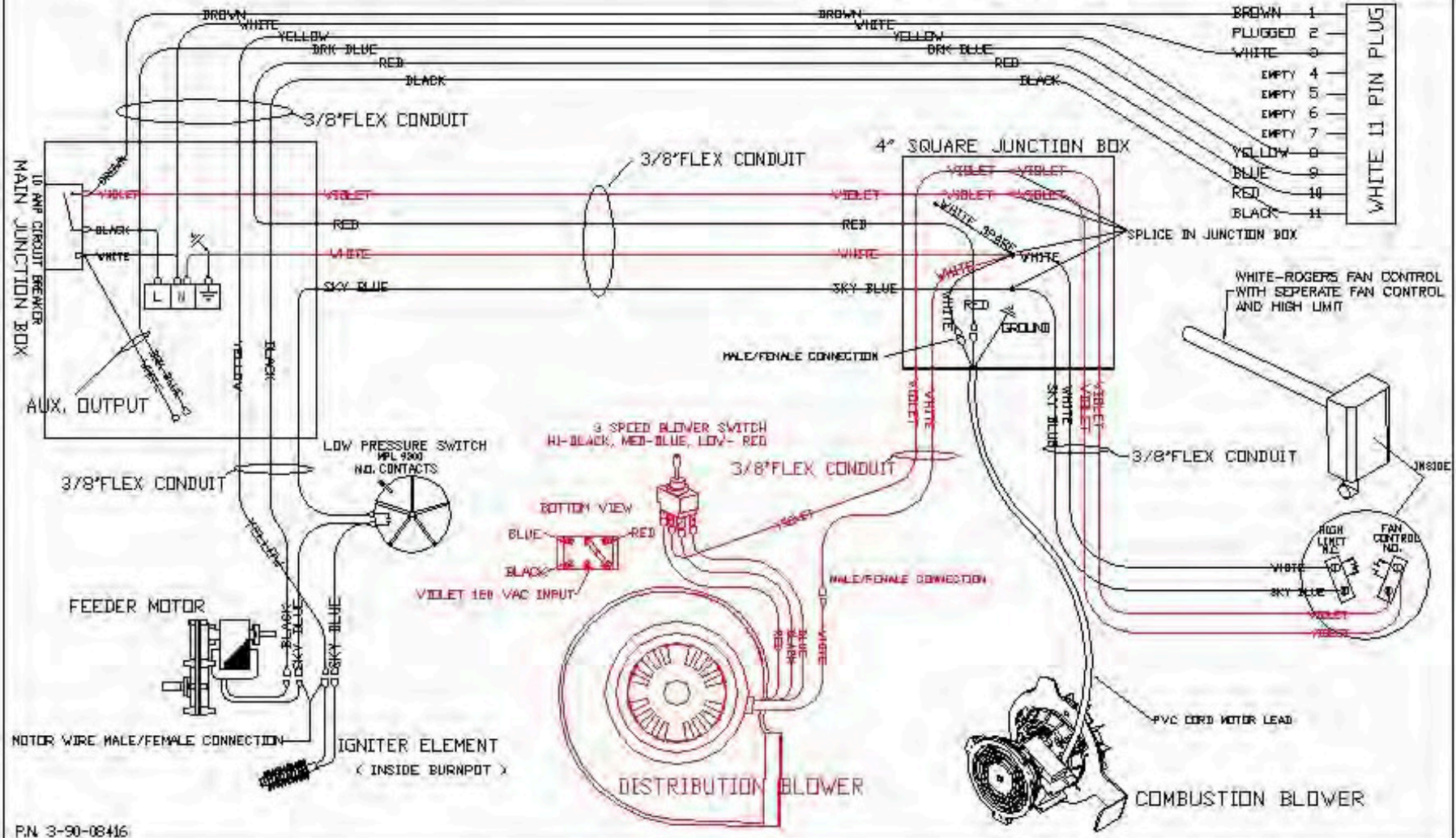

LOW VOLTAGE

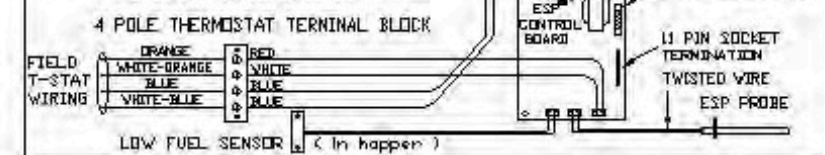

PN 3-90-08416

PF-100 Feed Motor Circuit

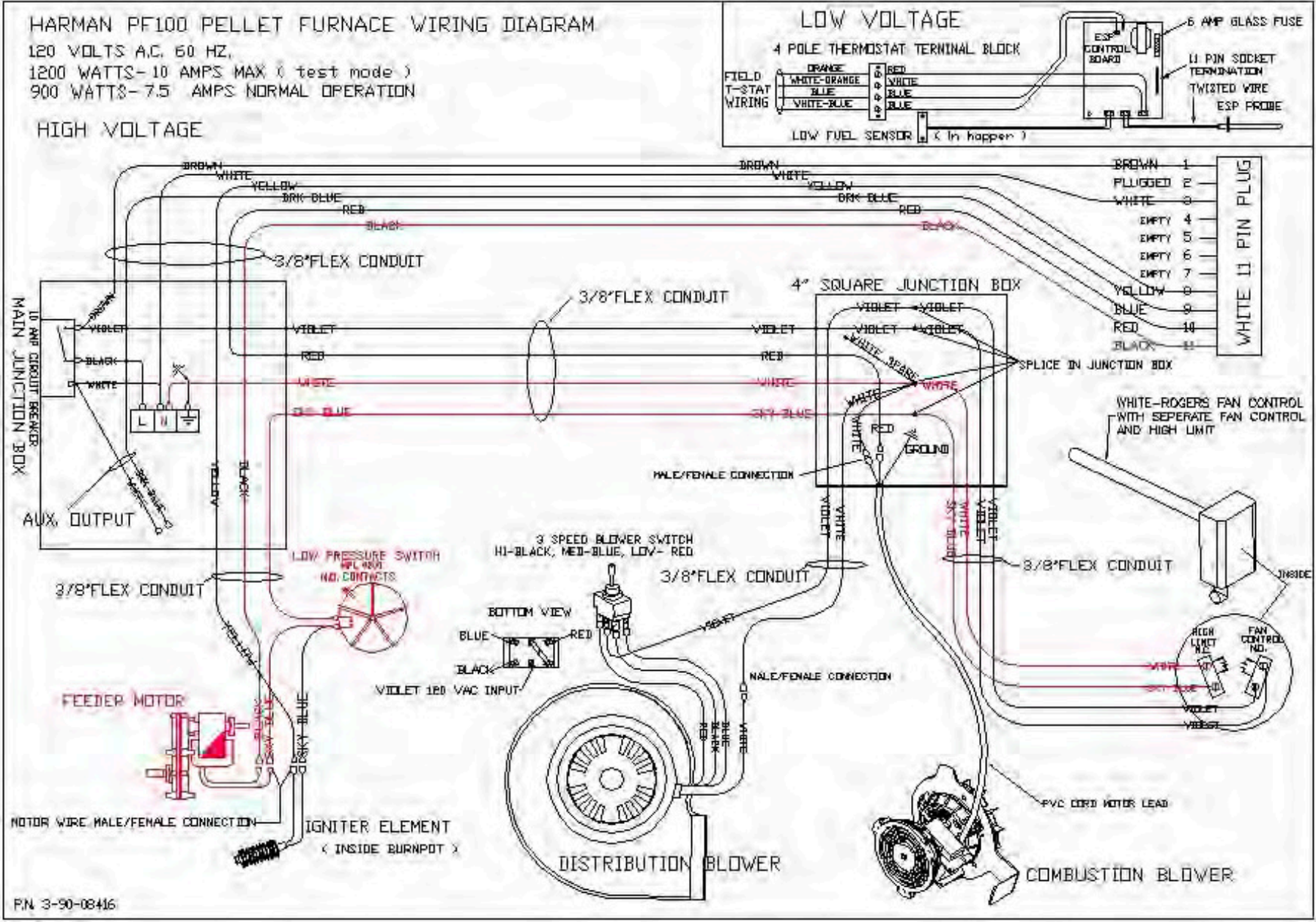

PF-100 Igniter Circuit

HARMAN PF100 PELLET FURNACE WIRING DIAGRAM

120 VOLTS A.C. 60 HZ.
 1200 WATTS-10 AMPS MAX (test mode)
 900 WATTS-7.5 AMPS NORMAL OPERATION

HIGH VOLTAGE

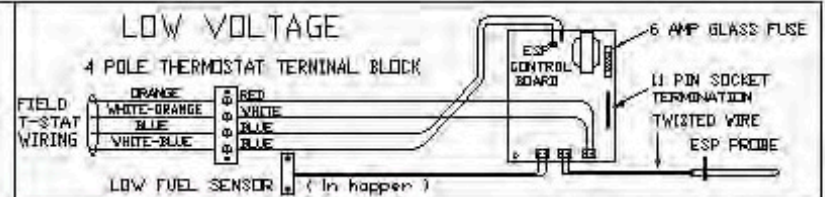
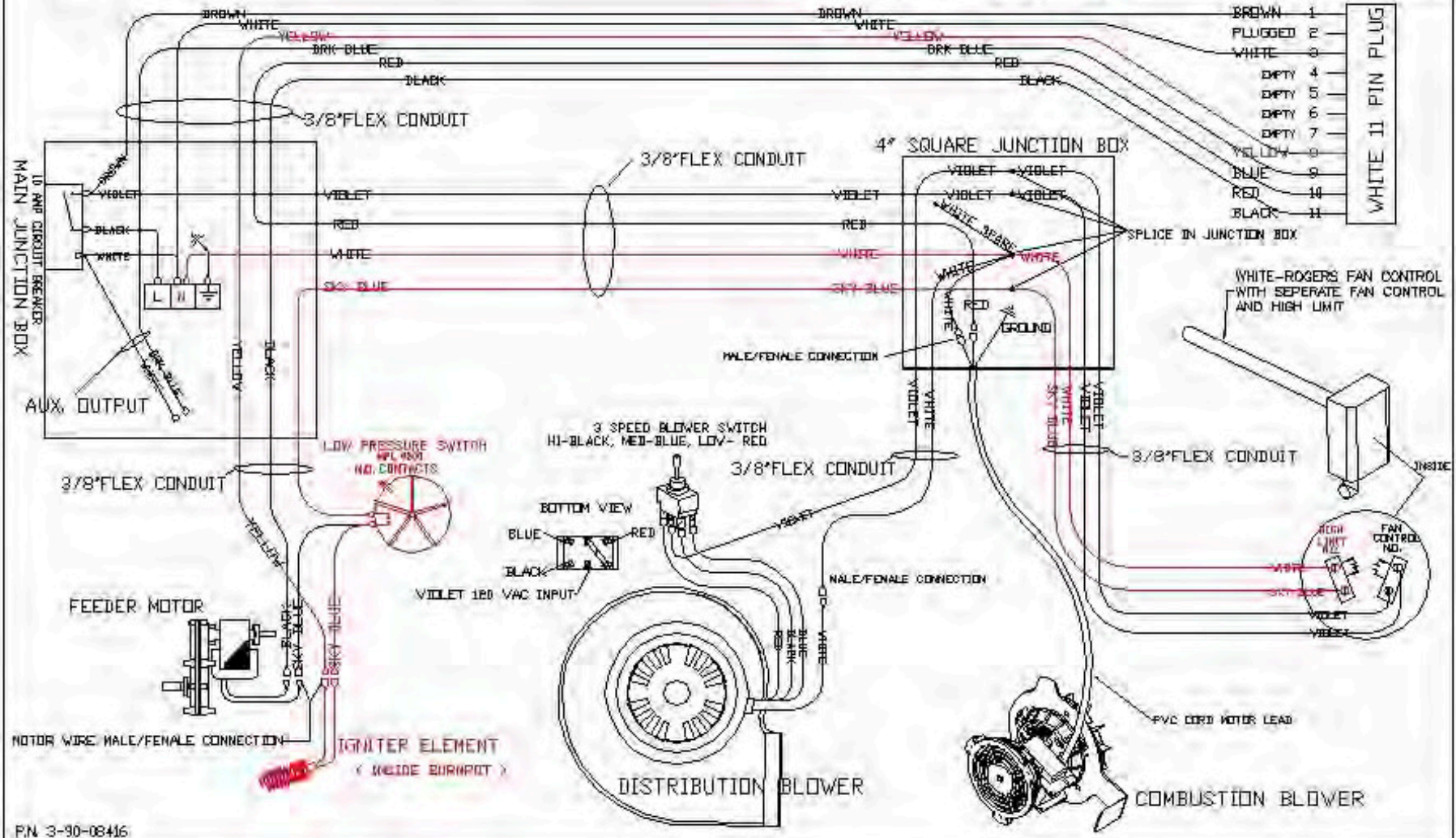

PN 3-90-08416

The ESP Probe

The ESP Probe is a thermister, it reports the exhaust temperature to the circuit board in a resistance reading. The resistance changes with every thousandth of a degree F. The wires on most probes are black, however, you could also see them in yellow or white. There is no difference in the probes beyond the wire color. Excessive dirt build-up on the probe or bent or damaged probes may send inaccurate temperature readings to the circuit board. Clean with alcohol or glass cleaner.

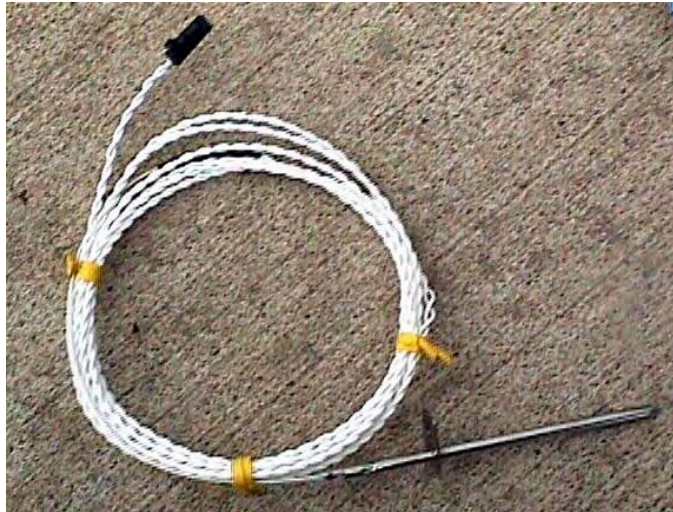

Part # 3-20-00744

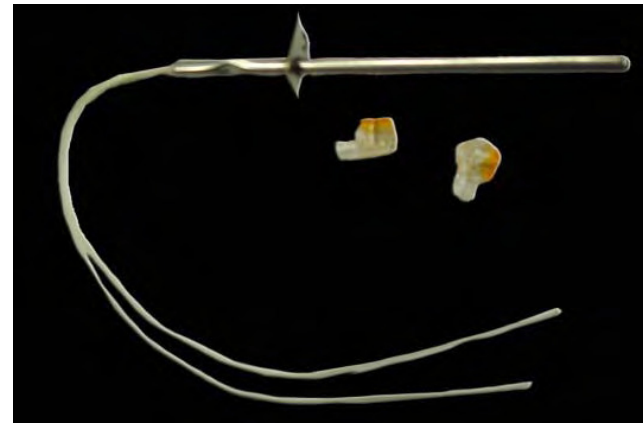

Part # 1-00-00744

For replacement purposes, Harman offers A splice kit for the ESP probe. When using the splice kit, you need to be sure to use only the gel connectors supplied with the kit.

Feeder Position Switch

Used on the Invincible Series, and older P-61's. Ensures that the slide plate is closing when the pusher arm returns. If the switch doesn't sense a full closure for a period of 30 minutes, it will cause the status light to blink "2 blinks". During this period, if the unit is turned to "off", it will not shut down until it runs out of fuel and the ESP probe cools naturally. **This switch has been eliminated on all current models.**

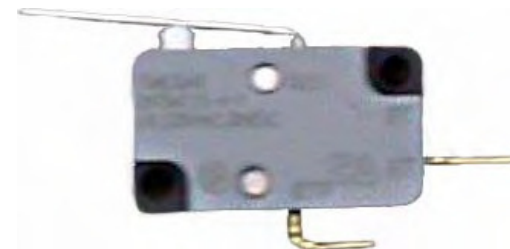
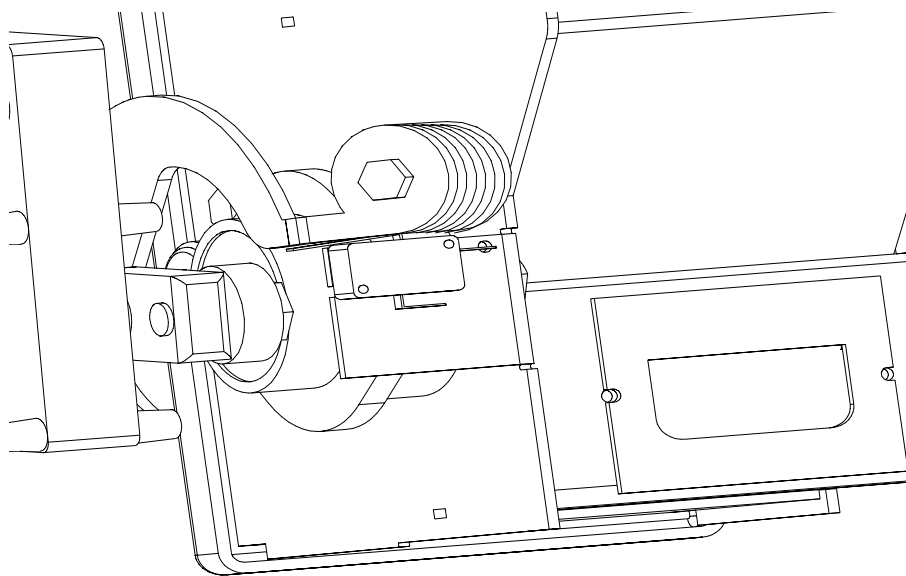

Draft Differential Switch



Diaphragm switch which is used to monitor the negative draft pressure in the firebox. The older blue switch can be used as a normally open (NO) or normally closed (NC) switch. In the Harman Pellet stoves, it is used as normally open. Notice the wire terminals are labeled NO, and NC The hose ports correspond to the wiring positions. When built, the hose port for NC is broken off and the wire terminal For NC is bent. This is to help prevent improper hook-up. The feed motor and igniter are wired through this switch and will not receive power if there is no draft, or if the draft is too low. The switch actuates at $-0.17''$ W.C. Even though the indicator light may be on showing power to the feed motor, the switch could still be intercepting the flow of current. The newer black switches can only be used as normally open.

Pellet Feed Motor

Most of the stoves use a 4 r.p.m. gear motor which installs directly into the end of the auger shaft and turns it in a counter-clockwise direction. The PF-100 uses a 6 r.p.m. motor.

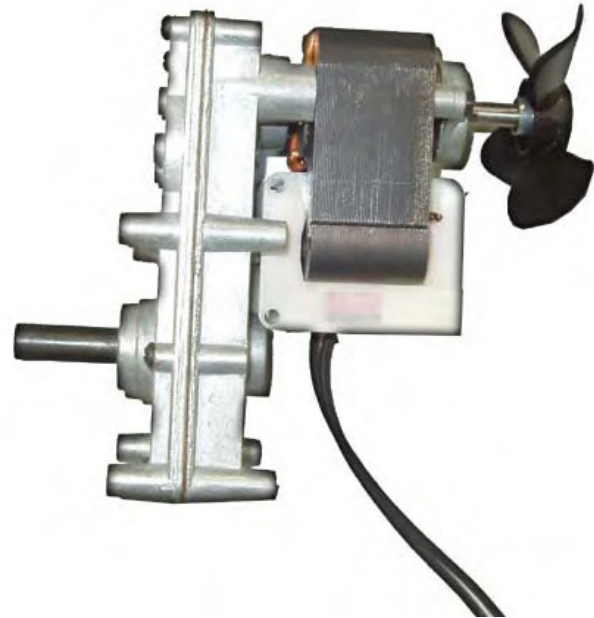

The Advance and Accentra models use a clockwise directional feed motor. This is identified by either two white leads, on older units or black and red leads on the newer ones. It is also a 4 r.p.m. Motor, just turning the opposite direction for the chain drive.

Igniter

Positioned in the bottom of the burn pot
Always air flowing over it (prevents burnout)
Easy access removal for cleaning

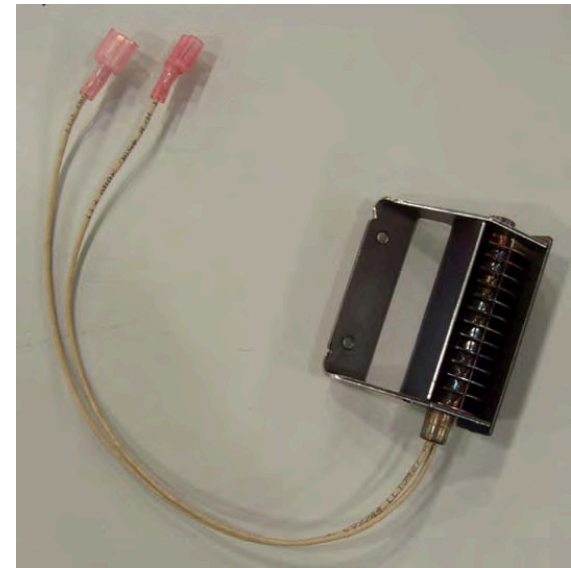
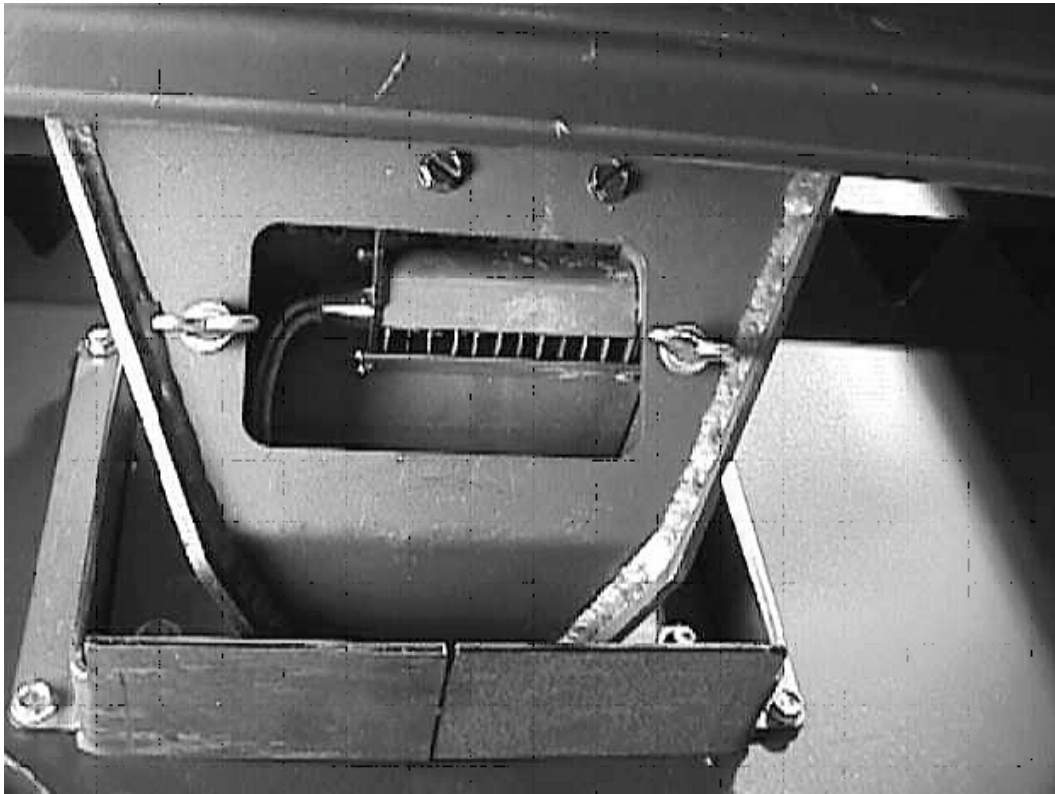

Important: when reinstalling an igniter, be sure the wires, within the burn pot, are pulled out of the rear of the feeder body as far as they can be to prevent melting. Only the leads from the igniter have Hi-temp Insulation.

Harman Pellet Stoves



Cleaning and Maintenance

Cleaning Procedures

Weekly Maintenance: Scrape pellet burn pot to remove carbon build up.

*Depending on fuel quality, more / less often.

Corn grate will need to be cleaned or changed.

Monthly Maintenance: Shut down stove for thorough cleaning. Scrape the heat exchanger, clean combustion blower fan blade. Inspect and clean the venting system. Clean out the fines collection area.

Each model will have different methods and access areas for cleaning,
But, all models have the same areas to clean



Harman Pellet Stoves

Technical Specifications

Component Specifications

Accentra				
Component	Harman Part #	Manufacturer #	Amperage	Resistance
Combustion Blower	3-21-08639	J238-112-11142	1.7	6.5ohms (+/- .6)
Feed Motor	3-20-08752	G/A 904-2520-A1506	1.5	7ohms (+/- .7)
Distribution Blower	3-20-29045A	EM3045LH	1.5	10.7 - 8.7ohms
Igniter	1-10-06620	N/A	N/A	50-54 ohms

Accentra Insert				
Component	Harman Part #	Manufacturer #	Amperage	Resistance
Combustion Blower	3-21-08639	J238-112-11142	1.7	6.5ohms (+/- .6)
Feed Motor	3-20-60906	J238-112-1147105	0.98	9ohms (+/- .9)
Distribution Blower	3-21-47120	Fasco B47120	2	11.7ohms (+/- 1.1)
Igniter	1-10-06620	N/A	N/A	50-54 ohms

Advance				
Component	Harman Part #	Manufacturer #	Amperage	Resistance
Combustion Blower	3-21-08639	J238-112-11142	1.7	6.5ohms (+/- .6)
Feed Motor	3-20-08752	G/A 904-2520-A1506	1.5	7ohms (+/- .7)
Distribution Blower	3-21-22647	Dayton 2C647A	0.65	30ohms (+/- 3)
Igniter	1-10-06620	N/A	N/A	50-54ohms

P-68				
Component	Harman Part #	Manufacturer #	Amperage	Resistance
Combustion Blower	3-21-08639	J238-112-11142	1.7	6.5ohms (+/- .6)
Feed Motor	3-20-60906	J238-112-1147105	0.98	9ohms (+/- .9)
Distribution Blower	3-21-22647	Dayton 2C647A	0.65	30ohms (+/- 3)
Igniter	1-10-06620	N/A	N/A	50-54ohms

Component Specifications -cont'd

P-61 A				
Component	Harman Part #	Manufacturer #	Amperage	Resistance
Combustion Blower	3-21-08639	J238-112-11142	1.7	6.5ohms (+/- .6)
Feed Motor	3-20-60906	J238-112-1147105	0.98	9ohms (+/- .9)
Distribution Blower	3-21-22647	Dayton 2C647A	0.65	30ohms (+/- 3)
Igniter	1-10-06620	N/A	N/A	50-54ohms
P-61				
Component	Harman Part #	Manufacturer #	Amperage	Resistance
Combustion Blower	3-21-08639	J238-112-11142	1.7	6.5ohms (+/- .6)
Feed Motor	3-20-60906	J238-112-1147105	0.98	9ohms (+/- .9)
Distribution Blower	3-21-22647	Dayton 2C647A	0.65	30ohms (+/- 3)
P-38 +				
Component	Harman Part #	Manufacturer #	Amperage	Resistance
Combustion Blower	3-21-08415	J238-087-8170	1.7/1.2	9ohms (+/- .9)
Feed Motor	3-20-60906	J238-112-1147105	0.98	9ohms (+/- .9)
Distribution Blower	3-21-22647	Dayton 2C647A	0.65	30ohms (+/- 3)
XXV				
Component	Harman Part #	Manufacturer #	Amperage	Resistance
Combustion Blower	3-21-08639	J238-112-11142	1.7	6.5ohms (+/- .6)
Feed Motor				
Distribution Blower				
Igniter	1-10-06620	N/A	N/A	50-54ohms

Component Specifications -cont'd

Invincible Insert				
Component	Harman Part #	Manufacturer #	Amperage	Resistance
Combustion Blower	3-21-00945A	J250-112-025300	1.5	5ohms (+/- .5)
Feed Motor	3-20-60906	J238-112-1147105	0.98	9ohms (+/- .9)
Distribution Blower	3-21-47120	Fasco B47120	2	11.7ohms (+/- 1.1)
PF-100 Furnace				
Component	Harman Part #	Manufacturer #	Amperage	Resistance
Combustion Blower	3-21-08639	J238-112-11142	1.7	6.5ohms (+/- .6)
Feed Motor	3-20-09302	108-010000620	0.7	14.5ohms(+/- 1.4)
1000 CFM Blower	1-10-01007	4C589	6.5	
1450 CFM Blower	1-00-00862	5C091	4	
2000 CFM Blower	3-21-52092	5C092	5.1	
Igniter	1-10-00400	N/A	N/A	34-35ohms(+/- 3)
PC-45 Corn Stove				
Component	Harman Part #	Manufacturer #	Amperage	Resistance
Combustion Blower	3-21-08639	J238-112-11142	1.7	6.5ohms (+/- .6)
Feed Motor	3-20-60906	J238-112-1147105	0.98	9ohms (+/- .9)
Distribution Blower	3-21-22647	Dayton 2C647A	0.65	30ohms (+/- 3)
Igniter	3-20-02677	N/A	N/A	36ohms (+/- 3)
Igniter Air Pump	3-20-02679	6015SE/115	0.35	130ohms (+/-13)

Automatic Circuit Board

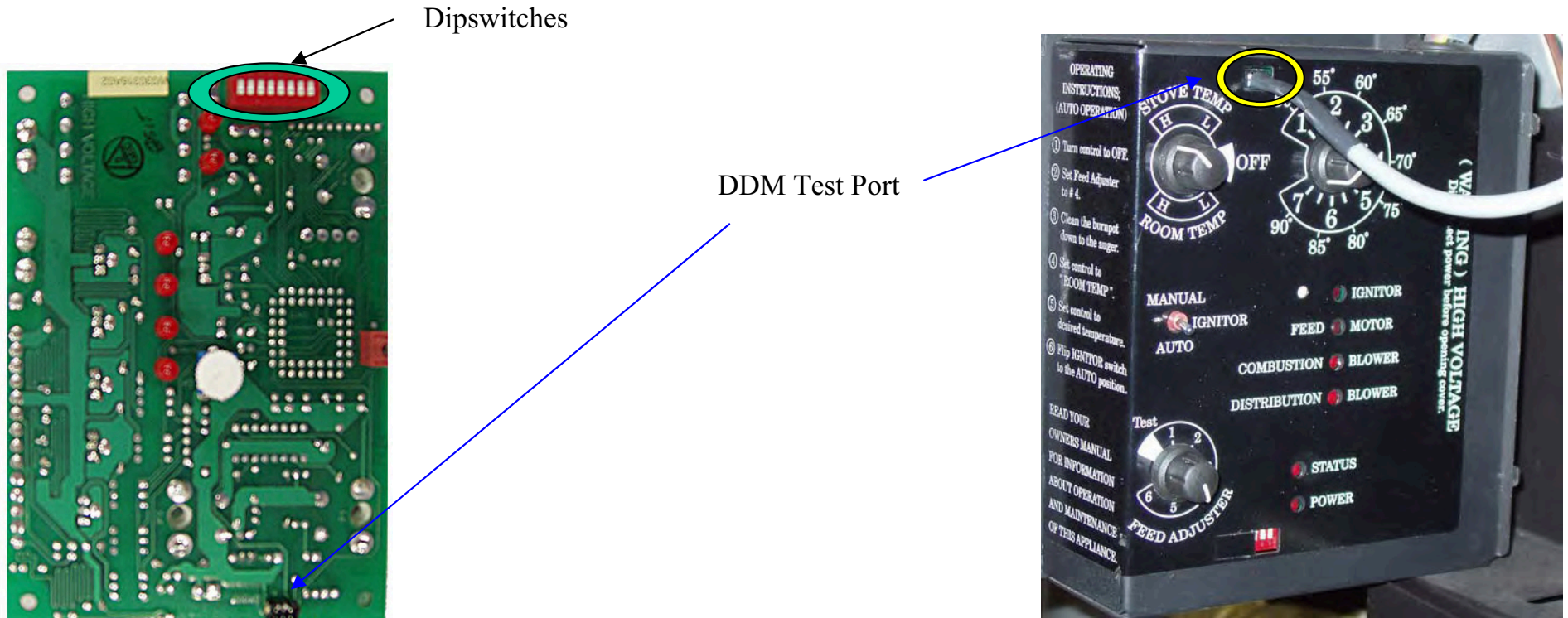

All Harman automatic pellet stoves now use the same circuit board. There is a series of switches on the board, (dipswitches), that are set differently depending on the stove model it is installed onto. Some switches allow for changing things such as ignition feed cycle, or igniter timing. Included on the new circuit board is a test port to attach the DDM, Digital Diagnostic Meter.

DIPSWITCH SETTINGS FOR 3-20-05374

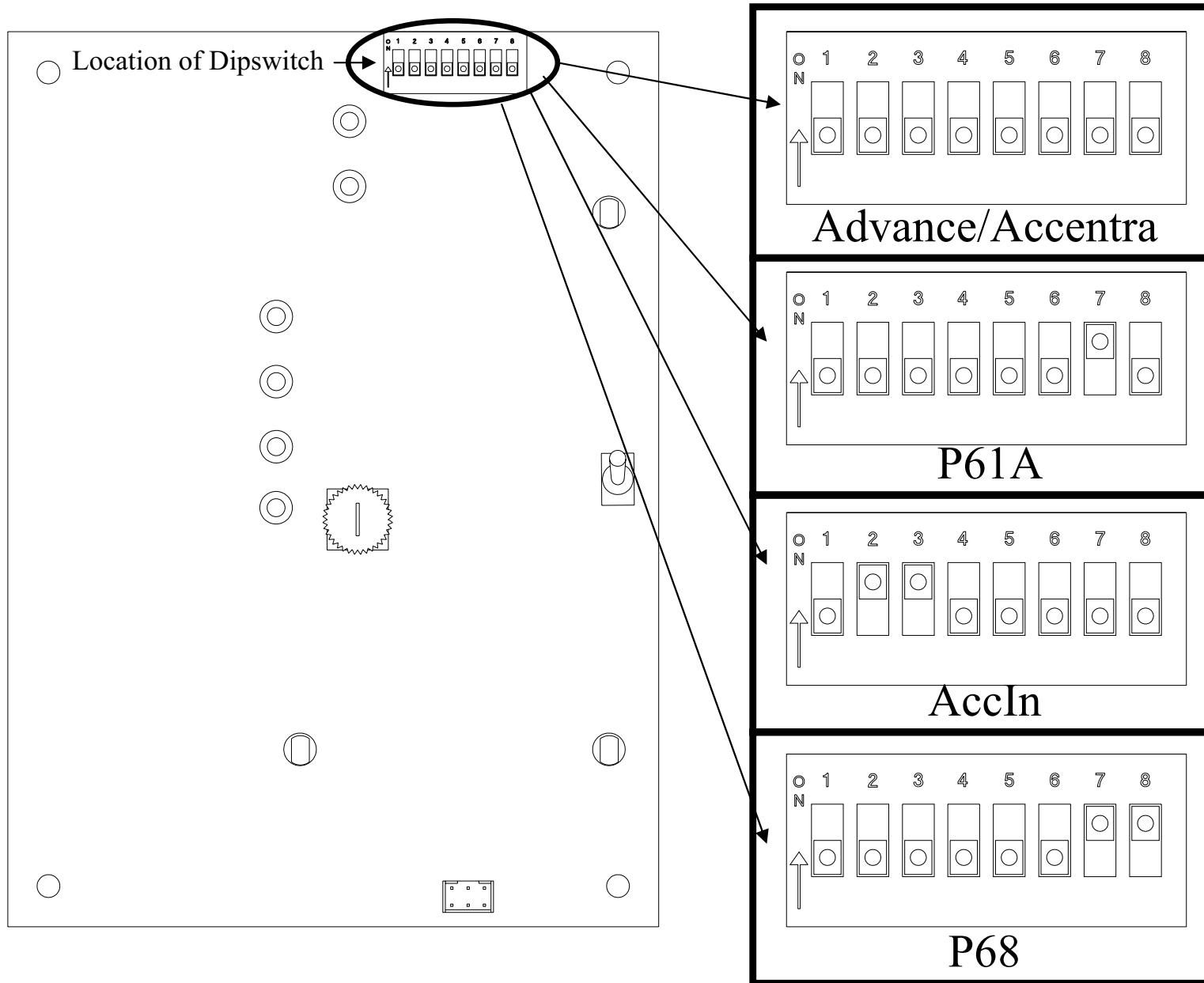

The Harman Digital Diagnostic Meter



Examples of information on the DDM:

a. Connected to
board #3-20-05374A

Dipswitch 01000011

b. ESP 266°F
Room Set Point 70°F
Room Sensor 71°F
Feed 10.0s Max 47.5s

Over-Fire Air Flow

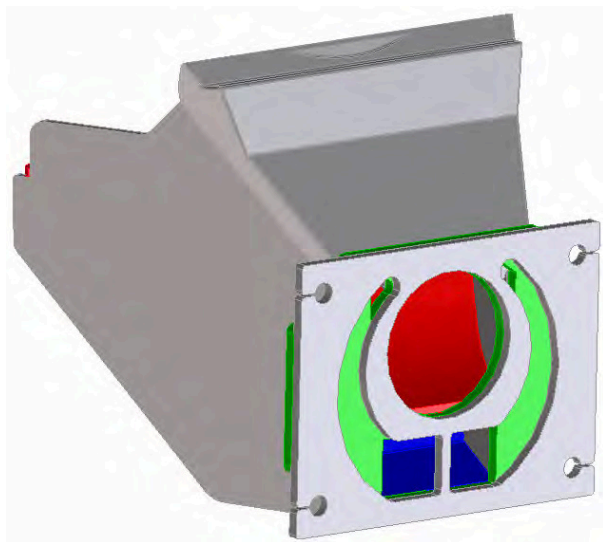

The Accentra Insert and the P-68 have their burnpots designed to accommodate over-fire air. This allows for a more complete burn because of total gas combustion

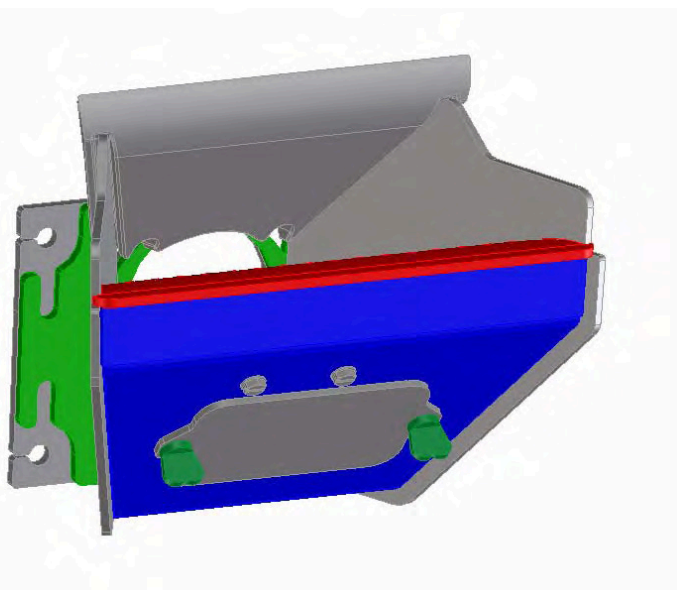

PC-45 Burn Pots

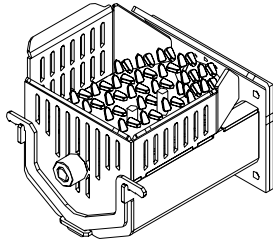

BURNPOT CORN

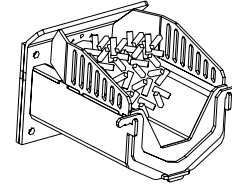

BURNPOT PELLET

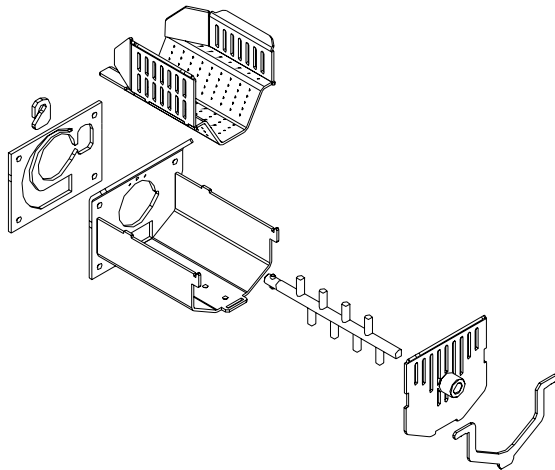

BURNPOT CORN

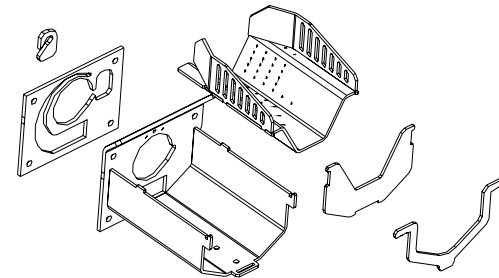

BURNPOT PELLET

