

#1) 70V  
 #2) Steps  
 19 int.  
 #4  
 #5

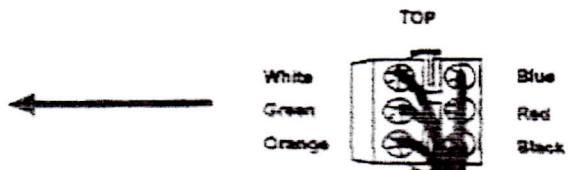

1.4 on (sec) = 1 P25  
 7. OFF (sec) on heat

12055902

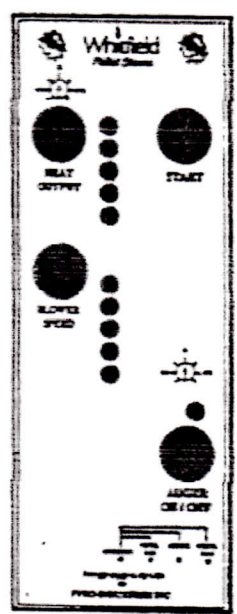
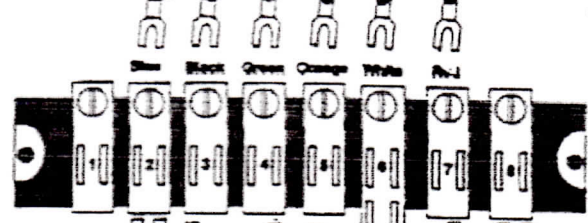
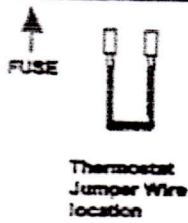

HIGH LIMIT SWITCH  
 normally closed  
 open 250  
 closes 230°

CONVECTION FAN  
 10-12 ohm  
 (+/-6)

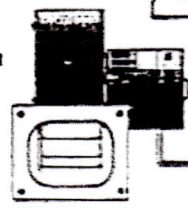

18 ohm  
 +/-4

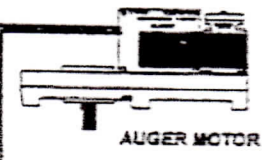

AUGER MOTOR

LOW LIMIT SWITCH  
 Normally open  
 closes at 140°  
 opens at 120°

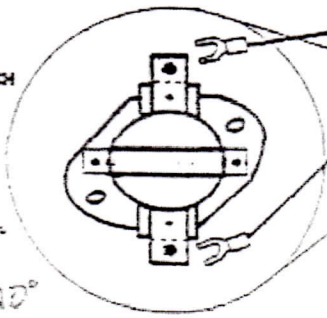

normally closed

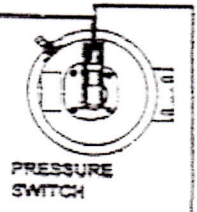

PRESSURE SWITCH

COMBUSTION FAN  
 18-20 ohm  
 +/-6

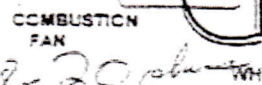

normally closed  
 opens 250°  
 closes 230°

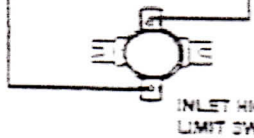

INLET HIGH LIMIT SWITCH

GROUND

BLACK

WALL PLUG



For Advantage Series Stoves  
 Serial Number Range 18145 - 74863

This shows using the new Control Board