



PREMIUM CHIMNEY SYSTEMS

FOR PROFESSIONAL INSTALLERS

PRODUCT CATALOG | 2021-2022



Follow us!



ARE YOU AN ICC DEALER?

Download marketing material and product information from the dealer account on **icc-rsf.com**. Get access and check it out!

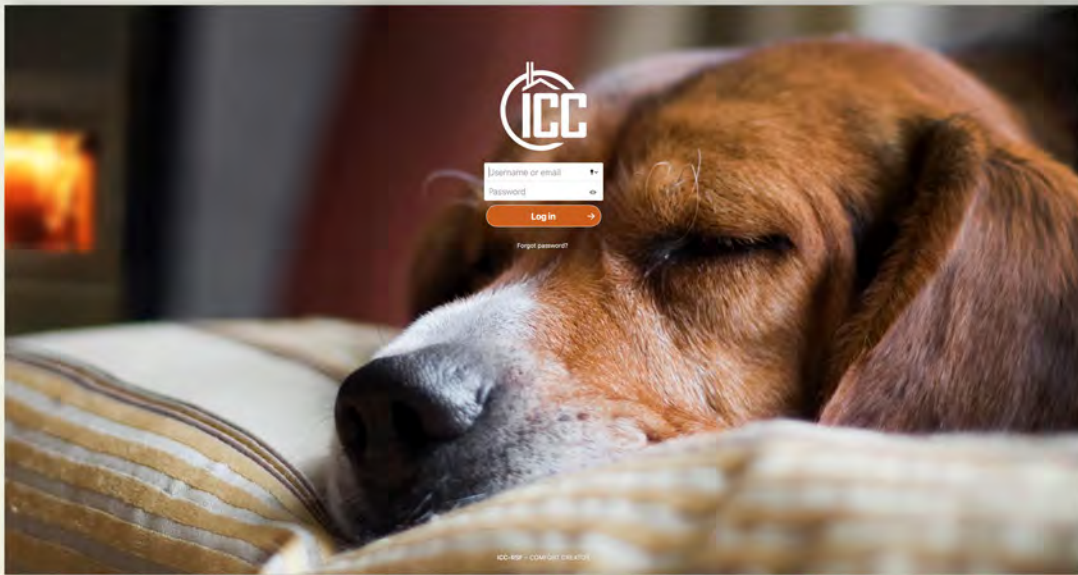

Le BOL
Grill

icc-rsf.com/LeBOL



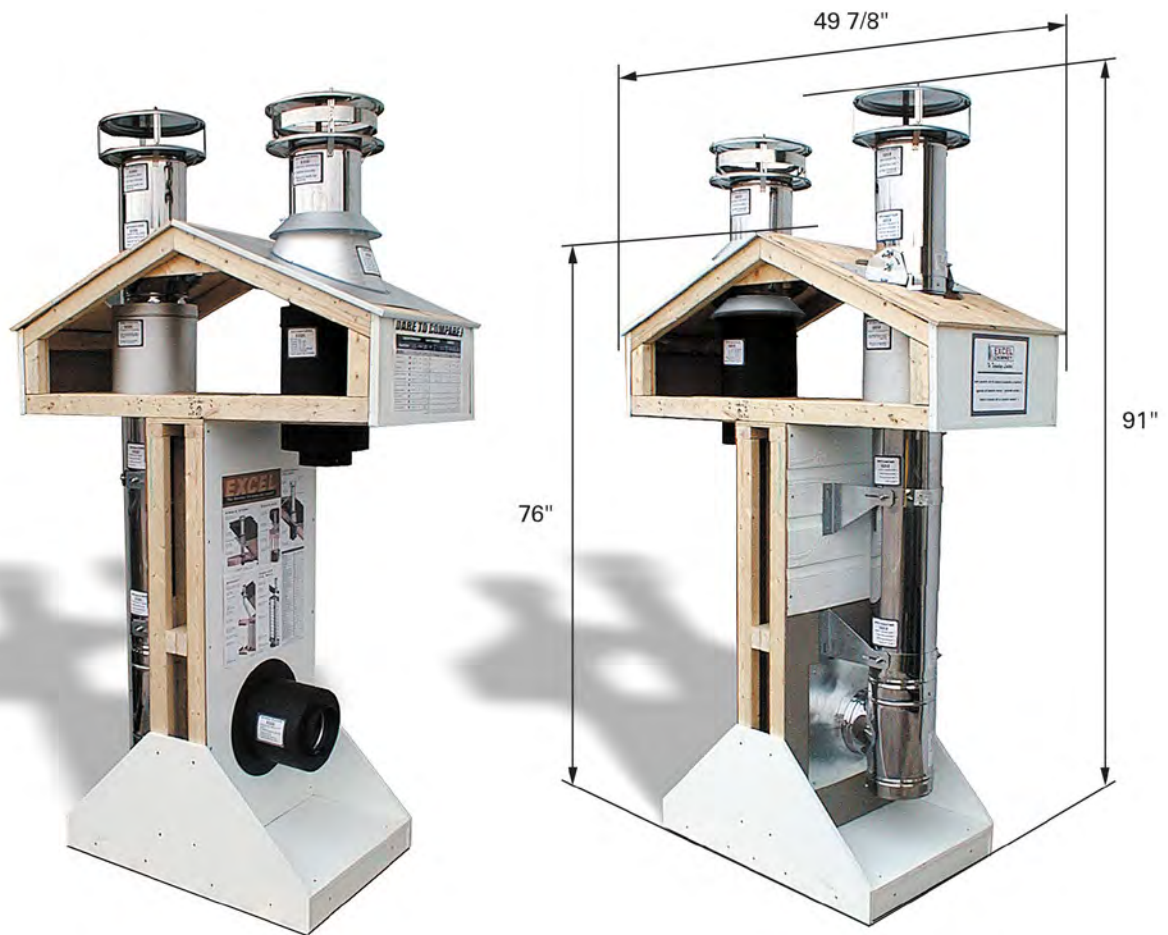

EXCEL POINT OF PURCHASE DISPLAY (AD-XLPOP)

The Excel POP Display helps the customer visualize what a chimney system would look like in their home. It displays the most commonly used parts in any system, including chimney lengths, a ceiling support, a flashing, tee, radiation shield, wall and roof supports and rain caps.

The display includes all of the chimney components required. It has a small footprint and can be easily moved around the showroom. It is indispensable in demonstrating EXCEL chimney to a customer.



EXCEL CHIMNEY POINT OF PURCHASE - POSTER (AD-XLPOP-2)

The EXCEL Chimney POP fits onto a 6" diameter length of EXCEL. It is designed to demonstrate the advantages of EXCEL over other brands of chimney. The installation examples along the edge are meant as a guide to help determine which components are required for specific installations.



ULTRABLACK POINT OF PURCHASE - POSTER (AD-UBPOP)

The Ultra Black POP display is a must-have for any showroom with woodstoves on display. It is designed to fit directly onto a one-foot length of Ultra Black which can be inserted into the flue of a display model.

GENERAL INFORMATION



Industrial Chimney Company was established in 1991 by a small group of partners with over 75 years combined experience in the chimney industry. Our experience convinced us that the needs of our ultimate customers (the people who live in a house with one of our chimneys) are served best when our products are sold by retailers who specialize in chimney and fireplaces. Specialty dealers understand the unique nature of our industry and are qualified to provide both technical support and installation. One of the cornerstones of our business is the conviction that hearth dealers are our essential partners in delivering the highest quality, safest chimney systems available.

From the beginning our objective has been to engineer products which enable better, faster installations while using fewer parts, thereby improving installation efficiency. This is the best way we know of to ensure that consumers benefit from safer installations and competitive pricing. Our goal is to do everything possible to help our business partners do the best installation possible for the homeowner.

We believe that our long-term accomplishments are tied to our commitment to people, both inside and outside of our company. While we are continuously investing in our plant and processes, the most gratifying returns come from the investments in people. Our greatest sense of accomplishment comes from when we see an employee or customer achieve their personal or business goals. That is why we continue to make major promotion and funding commitments to hearth industry education.

We focus our efforts in four areas. We manufacture residential venting, specifically insulated chimneys, single & double walled stove pipe and chimney liner for wood burning applications as well as venting products for pellet and gas appliances. We also manufacture two brands of wood burning fireplace with all customers needs in mind. The RSF brand is designed for heat and efficiency, while the Renaissance Fireplaces brand is designed for ambiance. In addition we manufacture commercial and industrial venting - everything from chimney liners to 48" diameter pressure stacks, which we sell through specialty reps in that market. From the beginning, our residential, commercial, and industrial venting products have enabled us to secure leadership roles in each segment of the industry.

Thanks to the strong support we have received from our distributors and dealers, our strategy is working. We have grown dramatically over recent years. Our 120,000 sq. ft. factory runs 24/7 all year round. It is located on more than 20 acres of prime industrial property and is filled with state-of-the-art machinery. We currently employ over 200 people.

This catalog contains information on our residential venting products and we have done our best to ensure it is complete and up-to-date. If you have any questions or concerns regarding any of our products please feel free to contact us directly. We will be pleased to assist you.

The ICC team

THE KEY TO OUR SUCCESS IS OUR PEOPLE

Making great, innovative products requires great, innovative minds. It is easy to look at a competing product and reproduce it; however, everything we do at ICC is the result of time, testing and engineering. We will make 50 different versions of one part, to make sure it satisfies the customer purchasing it and the dealer installing it.

We occasionally glance at our competitors' catalogs, only to find our components in their product lines. That's fine, because while they're following our lead, we're pushing forward with ideas and designs they haven't even dreamed of.



ICC's laboratory is DAP certified by UL, permitting us to test our new ideas without having to book independent lab time. This gives us freedom to be more creative and revolutionary.



TABLE OF CONTENTS

GENERAL INFORMATION	3
THE KEY TO OUR SUCCESS	4
LIST OF NEW AND UPDATED PARTS	5
WARRANTY	6

EXCEL | Insulated Stainless Steel Chimney

Technical Information	8
Typical Installations	9
Product Descriptions and Dimensions	10-19
Canadian Components	19
Offset Tables	20

ULTRABlack | Double Wall Stove Pipe

Technical Information	22
Engineering and Design Considerations	22
Product Descriptions and Dimensions	23-25
Offset Tables	26-27

EXCELPrime | Single Wall Stove Pipe

Technical Information	30
Engineering and Design Considerations	30
Product Descriptions and Dimensions	31-34
Offset Tables	35

EXCELiner | Rigid Stainless Steel Chimney Liner

Technical Information	38
Engineering and Design Considerations	38
Product Descriptions and Dimensions	39-42

Model RIS | Large Diameter Insulated Chimney

Technical Information	44
Product Descriptions and Dimensions	45-50
Components for Renaissance Fireplaces	49-50
Offset Tables	51

EXCELPellet | Venting for Pellet and Biofuels

Technical Information	54
Engineering and Design Considerations	54
Typical Installations	55
Product Descriptions and Dimensions	56-64
Offset Tables	64

EXCELDirect® | Venting for Direct Vent Gas Appliances

Technical Information	66
Design Considerations	66
Typical Installations	67
Product Descriptions and Dimensions	68-79
Aluminum Flex + Components	75-79
Manufacturer specific appliance adapters	80
Offset Tables	80

OPEN FIREPLACE CHIMNEY DESIGN CONSIDERATIONS	81
Chimney Sizing and Flue Height	81
Sizing Fireplace Chimneys	81

CHIMNEY HEIGHT DESIGN CONSIDERATIONS	82
Recommended Flue Height	82

INDEX	83-84
OTHER PRODUCTS	85

LIST OF NEW AND UPDATED PARTS

Model RIS | Large Diameter Insulated Chimney

Deluxe Rain Cap (RDRC)	46
------------------------------	----

EXCELDirect® | Venting for Direct Vent Gas Appliances

Coaxial Flex Adapter (ØCFA)	78
Faber Adapter (5AA8)	80

LIMITED LIFETIME WARRANTY FOR ICC VENTING PRODUCTS

Industrial Chimney Company (ICC) warrants all its venting products to be free from functional failure due to defects in material or workmanship for as long as the original consumer owns the chimney system (limited to 5 years for EXCELPrime). This warranty provides replacement of any components which fail as a result of normal use and includes replacement of any components damaged as a result of a chimney fire. (Note: Chimney fires are dangerous and preventable. We strongly encourage you to have your chimney cleaned regularly.) ICC warrants all stainless steel chimney components against perforation as a result of corrosion. This warranty does not cover damage caused to the building by chimney fires or misuse of the product.

No claims under this warranty will be honored unless ICC is notified of the potential claim and is given the opportunity to have one of its agents examine the chimney prior to replacement.

ICC will only be responsible for repair or replacement of any components found to be defective under this warranty. In no event shall ICC be responsible for any incidental or consequential damage caused by defects.

During the first ten years of the warranty (five years for EXCELPellet & EXCELDirect), ICC will provide replacement components except rain caps at no charge. During the balance of the warranty, ICC will provide replacement chimney components at 50% of the current retail price at the time of the warranty claim. This applies to all ICC venting products except for ULTRABlack Double Wall Stove Pipe and EXCEL Deluxe Rain Caps (EDRC), both of which are covered 100% for life.

ICC will not be responsible for labor of any kind required in the removal or replacement of any system replaced under this warranty.

Each venting product is designed to vent specific fuels only. This warranty is void if the venting is used in an application for which it is not designed.

EXCEL, EXCELiner, EXCELPrime, RIS and ULTRABlack:

Continuous 650°C (1200°F) temperature

Fuel: Wood, oil, coal, gas, charcoal

EXCELPellet:

Continuous 300°C (570°F)

Fuel: Wood pellet and agricultural products, natural gas, propane and liquid fuel

EXCELDirect®:

Gas-Fired Direct Vent appliances certified with EXCELDirect®

Fuel: Natural or LP gas

Model RIS:

Continuous 540°C (1000°F) temperature

Fuel: wood, oil, coal, gas, charcoal

All ICC systems must be installed according to the Installation Instructions which are included with every system at the time of purchase. If you do not have a set of installation instructions, they are available free upon request or online at:

<https://icc-rsf.com/chimney/residential/excel>

This warranty is void if the chimney is not installed according to the installation instructions.

This warranty may not be extended or modified by our agents or representatives.

This warranty is in lieu of all other express warranties or guarantees, of any kind.

EXCEL

ALL FUEL, INSULATED CHIMNEY SYSTEM 5" – 8"



EXCEL Technical Information

Certification

EXCEL is tested and listed by Intertek Testing Services to two safety standards:

UL 103HT - The standard for solid and liquid fuel chimneys installed in the USA. Along with many other tests the UL 103HT Standard requires the chimney to withstand three 10 minute chimney fires at 2100°F (1150°C).

ULC S-629 - The standard for solid and liquid fuel chimneys installed in Canada. Along with many other tests the ULC S-629 Standard requires the chimney to withstand three 30 minute chimney fires at 2100°F (1150°C).

Applications

EXCEL chimney is suitable for use on appliances that burn:

- Wood
- Oil
- Coal
- Gas
- Charcoal

It is specifically engineered for wood burning stoves, fireplaces and residential furnaces.

Allowable Flue Gas Temperatures

	ULCS629 (Canadian)	UL103HT (USA)
Max Continuous	650°C (1200°F)	538°C (1000°F)
Brief Forced Firing	925°C (1700°F)	760°C (1400°F)
Tested To	1150°C (2100°F)	1150°C (2100°F)

Clearance to Combustible Materials

2" clearance except in areas protected by factory-built supports certified for reduced clearance. EXCEL round and square supports permit the chimney to be installed with approximately 1 inch of clearance - in the area shielded by the support.

Construction

Flue: .016" 304 or FW2 stainless steel

Casing: .016" 430 stainless steel

Seam: Interior and exterior seams are continuous seam welded

Insulation: Thermoplus continuous blanket

Wall thickness: 1"

Paint: All black EXCEL components are painted with Forrest "Stove Bright" flat black paint

EXCEL Dimensions and Support Capacities

Chimney size	5"	6"	7"	8"
Rough opening required	(INCHES)			
Round support (ERDS)	10 x 10	10 x 10	11 x 11	12 x 12
Square support (ESS)	N/A	10 x 10	11 x 11	12 x 12
Roof support (ESR)	11 x 11	12 x 12	13 x 13	14 x 14
Offset support (EOS)	11 x 11	12 x 12	13 x 13	14 x 14
Radiation shield (ERS, ERSA & ERSC)	11 x 11	12 x 12	13 x 13	14 x 14
Wall radiation shield (EWRS)	10 x 10	10 x 10	11 x 11	12 x 12
Maximum height per support	(FEET)			
Round support (ERDS)	65	55	50	45
Square support (ESS)	N/A	55	50	45
Roof support (ESR)	65	55	50	45
Wall support (EWS)	50	44	37	35
Offset support (EOS)	35	30	27	25

Radiation shields must be used at all floor joist and ceiling areas



EXCEL has been tested and listed to the UL 103HT and ULC S-629 chimney standards by INTERTEK.

EXCEL Typical Installations

NOTE: The following information is provided to assist you in selecting the chimney components required for your installation. It is intended to be a guideline only. These are not the installation instructions.

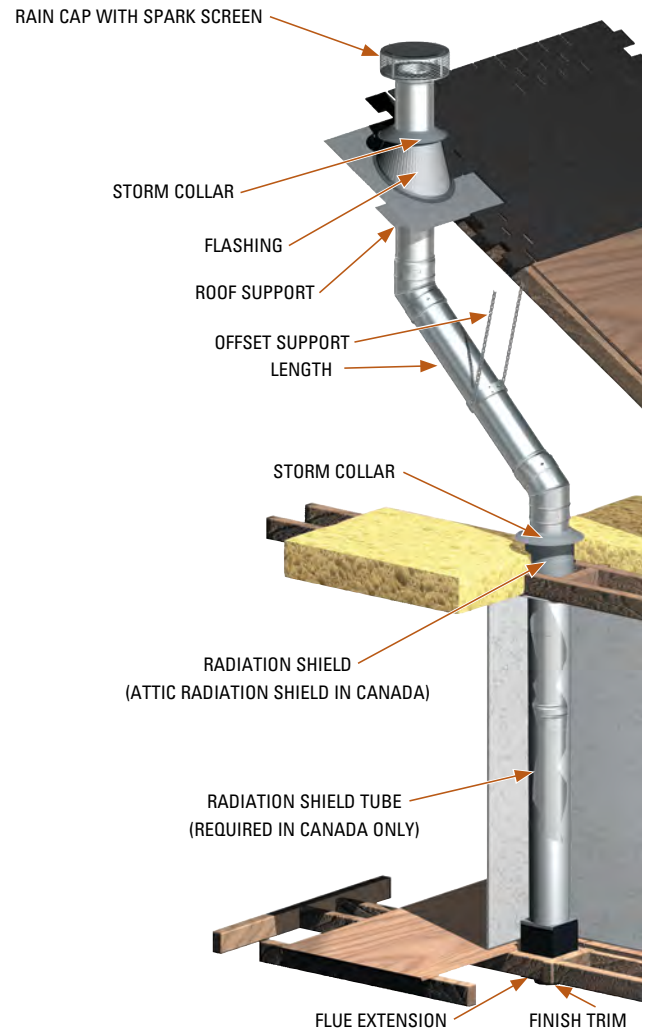
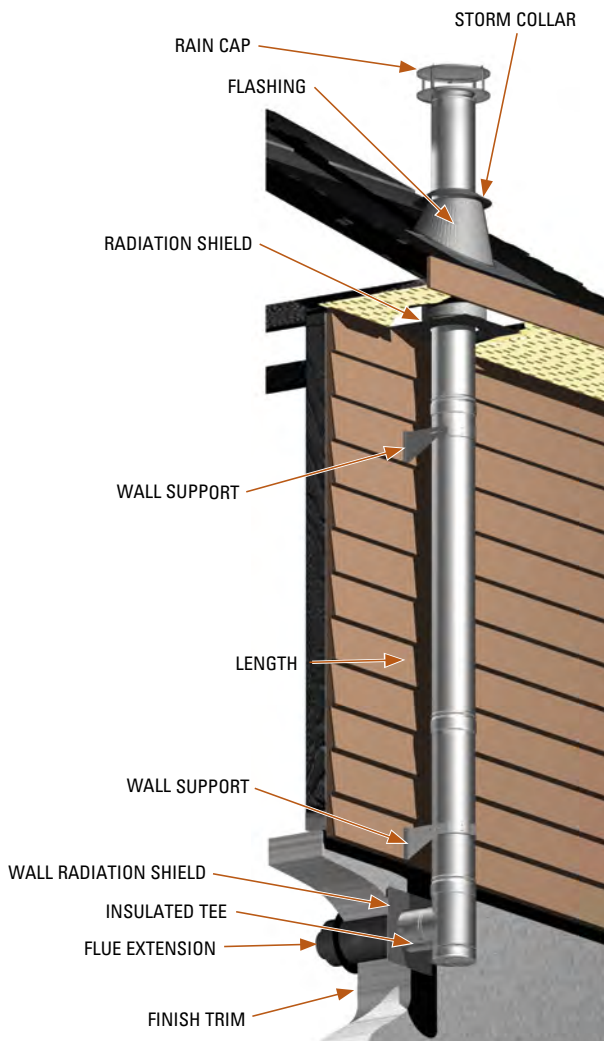
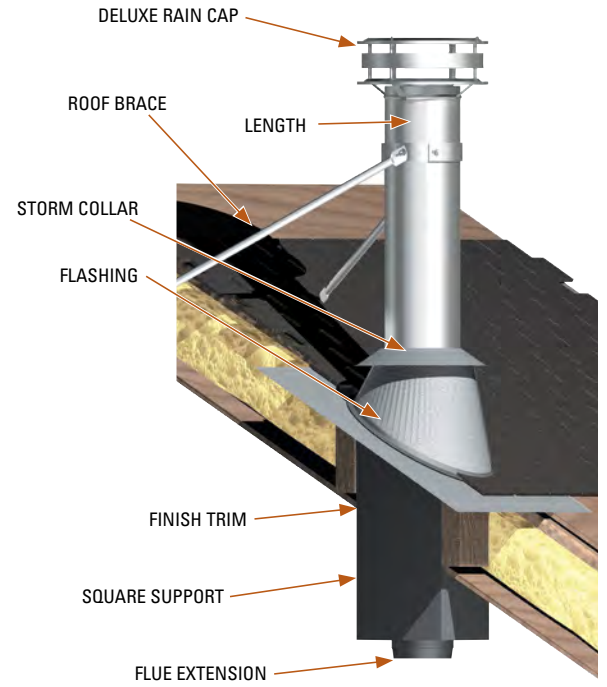
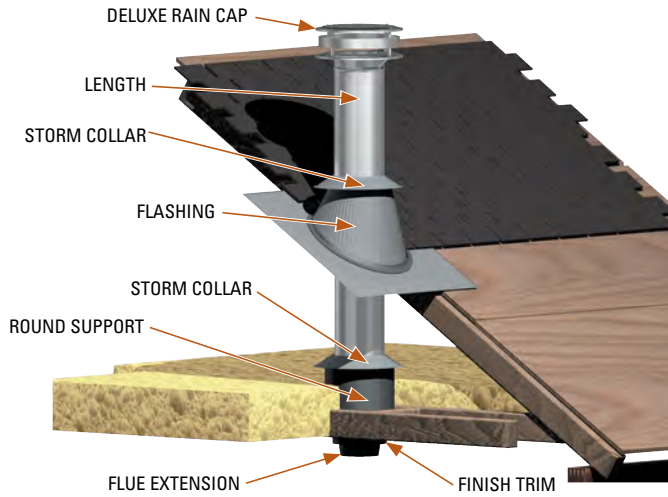

EXCEL Product Descriptions

Insulated Lengths

(EL48, EL36, EL24, EL18, EL12, EL6)



EXCEL chimney lengths are available in 48", 36", 24", 18", 12" & 6" lengths. To determine the installed length deduct 1 1/2" from the overall length.

INCHES

Insulated Lengths						
Inside diameter			5	6	7	8
Outside diameter	Nominal		7	8	9	10
	Outside of Bead		7 1/4	8 1/4	9 1/4	10 1/4
Weight - lbs/foot			3.6	4.2	4.9	5.3
Nominal length	48	36	24	18	12	6
Installed length	46 1/4	34 1/4	22 1/4	16 1/4	10 1/4	4 1/4

Insulated Adjustable Lengths

(ELA18)



The most common applications for the adjustable length are:

- Between elbows so that any required centre-to-centre offset can be achieved.
- When it is necessary to balance the chimney height so that the caps line up for functional or aesthetic reasons.
- When a specific horizontal offset is required.

The adjustable length must be installed above a straight chimney length. It will not adjust into an elbow or tee. To determine the installed length deduct 1 1/2" from the overall length. To adjust the length, remove the screws, slide the sections of the outer casing together to the desired length and cut away the excess insulation. Do not cut the inner flue, it will slide inside the next chimney length.

INCHES

Insulated Adjustable Lengths	
Nominal length	18" adjustable
Installed length	9 1/2 - 16 1/4

Insulated Tees

(ETI)

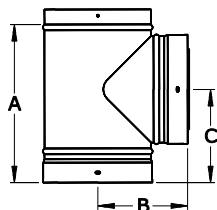

The insulated tee can be used on the interior or exterior of a building. The tee is designed to be used in combination with a wall support assembly. The EXCEL tee cap has a handle on the bottom to simplify removal for cleaning. An ETC Tee Cap is included.

INCHES

Dimensions			
Code	A	B	C
5ETI	11 1/4	6 3/4	6 1/4
6ETI	12 1/4	7 1/4	6 3/4
7ETI	13 1/4	7 3/4	7 1/4
8ETI	14 1/4	8 1/4	7 3/4

Tee Cap

(ETC, EITC)



ETC

An ETC Tee Cap is included with the EXCEL Insulated Tee and an EITC Insulated Tee Cap is optional. If a replacement tee cap is required, either version tee cap can be ordered. The EITC Insulated Tee Cap has an insulated plug that reduces heat loss from the bottom of the chimney system. The Insulated Tee Cap does not reduce clearance to combustibles, but will help maintain higher flue temperatures.

Chimney Top Damper

(ETD)

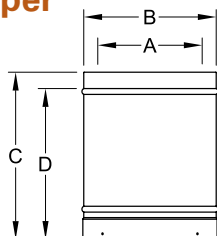

Adding this "Top Damper" to a system seals it right at the top of the chimney. The "Chimney Top Damper" is placed directly below the cap and is designed to prevent any cold air infiltration into the house through the chimney. It functions on a chain that hangs down to the firebox and comes with 30' of wire.

INCHES

Dimensions				
Code	A	B	C	D
7ETD	7	9	12	10 1/4
8ETD	8	10	12	10 1/4

Elbows

(EE15, EE30 & EE45)

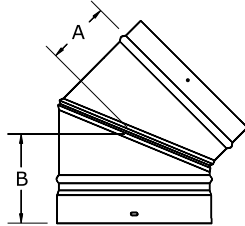

EXCEL 15° and 30° elbows are tested and listed to UL 103HT and ULC S629 Standards. EXCEL 45° elbows are certified to ULC S629 only.

Dimensions		
Code	A	B
5EE15	1 7/8	2 7/8
6EE15	1 7/8	2 7/8
7EE15	2	3
8EE15	2	3
5EE30	2 3/8	3 3/8
6EE30	2 1/2	3 1/2
7EE30	2 5/8	3 5/8
8EE30	2 3/4	3 3/4
Canada only		
5EE45	2 7/8	3 7/8
6EE45	3	4
7EE45	3 1/4	4 1/4
8EE45	3 1/2	4 1/2

Wall supports - Wall Bands (EWS) Extended Wall Supports (EWSE)

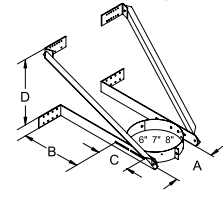
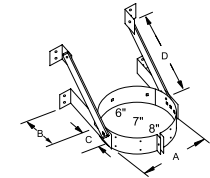
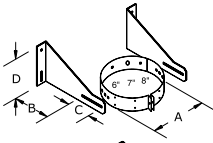

Old Style Wall support (EWS-R)

Extended Wall support (EWSE)

The wall support (EWS) is used to support a vertical chimney on a through-the-wall installation. The EXCEL Wall Support installs on the first length of chimney above the tee, (not below the tee, thus making it easier to fasten the support to framing, instead of into concrete). The Wall Support utilizes the universal band to fit 6, 7, & 8 inch chimneys. It is designed to slide in and out to fit a variety of wall profiles. The Wall Support is also used as a lateral support every 8 feet in height. The Extended Wall Support (EWSE) will allow the chimney to pass by a 12" overhang. It often eliminates the need to either offset a chimney around the overhang or cut and finish the soffit and fascia. One support is required every 8', minimum of two per system. The Old Style Wall Support (EWS-R) is generally more complicated to install than the EWS. However it simplifies installations on irregular surfaces like vinyl siding.

EWS Dimensions (Fits 6", 7" & 8" chimney)				
Code	A	B	C	D
EWS	7, 8, 9 or 10	5	3 1/2	6
EWS-R	8, 9 or 10	5	3 1/2	16
EWSE Dimensions (Fits 6", 7" & 8" chimney)				
Code	A	B	C	D
EWSE	8, 9 or 10	12 1/4	6 1/2	13

Roof Support

(ESR)

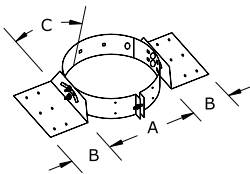

The roof support is primarily used when it is difficult to use a round or square support in a cathedral ceiling. It can also be used above an offset, or to provide additional support when the chimney height exceeds the capacity of the primary support. The roof support utilizes a universal band, so that the same support fits 6, 7, & 8 inch chimneys. It is made with adjustable brackets, which allows it to adjust easily to any roof pitch.

Dimensions (Fits 5", 6", 7" & 8" chimney)			
Code	A	B	C
ESR	7, 8, 9 or 10	6	Fits flat - 24 / 12

Offset Support

(EOS)

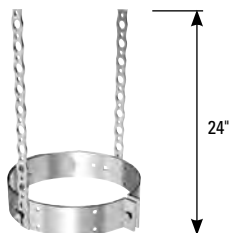

The offset support is primarily used to re-support the chimney above an offset. However, it can also be used to provide additional support when the chimney height exceeds the capacity of the primary support. The offset support straps are 24 inches long.

Round & Square Supports

(ERDS, ERDSI & ESS)

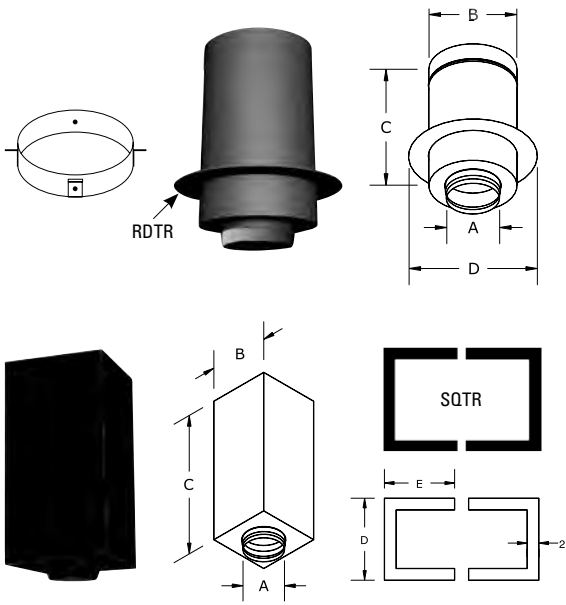

EXCEL's ceiling supports are suitable for use on flat or sloping ceilings. They must project into the room a minimum of 3 inches on a flat ceiling. For sloping ceilings, see the EXCEL installation manual. These supports are designed to act as a combination of support and attic radiation shield. To use either support as an attic radiation shield, simply close the open area at the top of the support (in the attic) with a storm collar. Clearance to the exterior of EXCEL chimney is reduced to 1" while inside the support or support extension.

Insulated Round Support (ERDSI)

The Insulated round support includes an insulation wrap for the chimney length inside the support and an insulated firestop to be sealed to the vapour barrier.

INCHES

Round Support Dimensions				
Code	A	B	C	D
5ERDS / ERDSI	5	10	24	14 1/4
6ERDS / ERDSI	6	10	24	14 1/4
7ERDS / ERDSI	7	11	24	15 3/4
8ERDS / ERDSI	8	12	24	17

Storm collar (ESC) ordered separately.

Square Support Dimensions					
Code	A	B	C	D	E
6ESS	6	10	24	14	12
7ESS	7	11	24	15	12
8ESS	8	12	24	16	12

Storm collar (ESQSC) ordered separately.

Support Extensions

(ERDSE & ESSE)

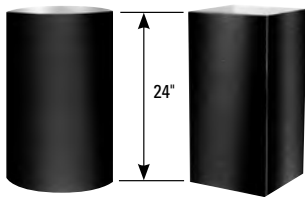

Support extensions are available to facilitate installations on very steep pitched ceilings, or where the chimney must project unusually far into the room. Both the round and square support extensions are 24" long. Clearance to the exterior of EXCEL chimney is reduced to 1" while inside the support or support extension. Thus, there is zero clearance to the exterior of the support or support extensions.

Pitched Trim Rings

(ERTA, B, C & ECTA, B, C)

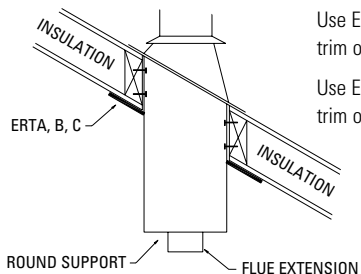
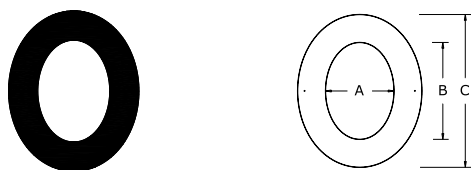

Use ERTA, B, C for pitched trim on Round Support.

Use ECTA, B, C for pitched trim on EXCEL lengths.

If you are installing a round support on a sloping ceiling, or passing EXCEL through a pitched ceiling without a support, you will require a pitched trim ring. Use the following table to determine the correct trim ring for your installation. Pitched trim rings are not available in 5" Ø. The finish trim which comes with the square support, is adjustable for any ceiling pitch from flat to 24/12. Not available in 5" Ø.

INCHES

Pitched Trim Ring Dimensions						
Trim For	Code	A	B	C	Pitch Range	
ERDS/ERDSI	6ERTA	9 13/16	10 1/8	18 1/2	0/12 - 4/12	
ERDS/ERDSI	7ERTA	10 13/16	11 3/16	18 1/2	0/12 - 4/12	
ERDS/ERDSI	8ERTA	11 13/16	12 1/4	18 1/2	0/12 - 4/12	
ERDS/ERDSI	6ERTB	9 13/16	11 3/8	18 1/2	4/12 - 8/12	
ERDS/ERDSI	7ERTB	10 13/16	12 1/2	18 1/2	4/12 - 8/12	
ERDS/ERDSI	8ERTB	11 13/16	13 5/8	18 1/2	4/12 - 8/12	
ERDS/ERDSI	6ERTC	9 13/16	13 7/8	18 1/2	8/12 - 12/12	
ERDS/ERDSI	7ERTC	10 13/16	15 1/4	21 1/4	8/12 - 12/12	
ERDS/ERDSI	8ERTC	11 13/16	16 11/16	21 1/4	8/12 - 12/12	
EXCEL	6ECTA	8 1/16	8 3/8	16 3/8	0/12 - 4/12	
EXCEL	7ECTA	9 1/16	9 3/8	17 3/8	0/12 - 4/12	
EXCEL	8ECTA	10 1/16	10 7/16	18 1/2	0/12 - 4/12	
EXCEL	6ECTB	8 1/16	9 5/16	17 3/8	4/12 - 8/12	
EXCEL	7ECTB	9 1/16	10 1/2	18 1/2	4/12 - 8/12	
EXCEL	8ECTB	10 1/16	11 5/8	19 5/8	4/12 - 8/12	
EXCEL	6ECTC	8 1/16	11 3/8	19 3/8	8/12 - 12/12	
EXCEL	7ECTC	9 1/16	12 13/16	20 7/8	8/12 - 12/12	
EXCEL	8ECTC	10 1/16	14 1/4	22 1/4	8/12 - 12/12	

Wall Radiation Shields

(EWRS & EWRSI)

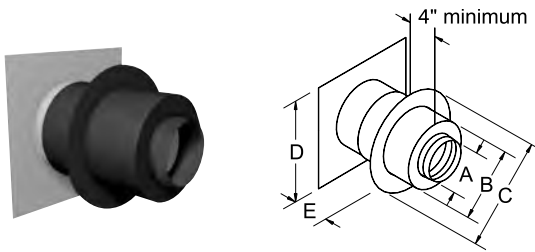

The wall radiation shield is used when the chimney passes horizontally through a combustible wall. The EWRS telescopes to adjust for wall thickness from 6" – 12", so no painting is required. The inside finish trim is removable from the EWRS, allowing for easy installation before or after the wall finish is applied. The Insulated Wall Radiation Shield (EWRSI) is designed for installations in energy efficient houses which have tightly sealed vapour barriers.

Insulated Wall Radiation Shield (EWRSI)

The EWRSI is fully insulated and has a flange to permit an airtight seal to the vapour barrier. It can be installed into an existing home but since it must be installed under the drywall it is most often used for new construction. Flue extension and trim ring included.

INCHES

Dimensions					
Code	A	B	C	D	E
5EWRS/EWRSI	5	10	14 1/4	16 X 16	6-12
6EWRS/EWRSI	6	10	14 1/4	16 X 16	6-12
7EWRS/EWRSI	7	11	15 3/4	16 X 16	6-12
8EWRS/EWRSI	8	12	17	16 X 16	6-12

Stainless Trim for EWRS (EST)

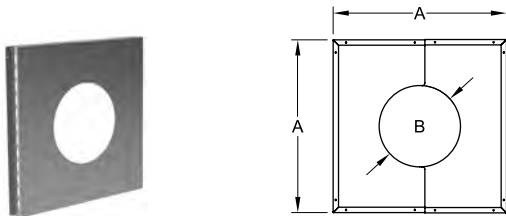

A decorative trim cover for the exterior wall plate of the Wall Radiation Shield that prevents water infiltration while providing adequate heat ventilation. It is constructed from two separated pieces and can be added at any point.

INCHES

Dimensions		
ø	A	B
6"	16 1/4	8"
7"	16 1/4	9"
8"	16 1/4	10"

Insulated Angled Wall Radiation Shields

(EWRSI30 & EWRSI45)

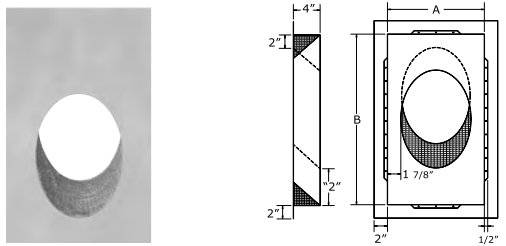

The insulated angled wall radiation shield is used when the chimney goes through a combustible exterior wall, with a 30 or 45 degree angle. A radiation shield is installed on the exterior side of the wall to complete the installation. This part is used for fireplace installations only.

Note: 45° are approved for use in Canada only.

INCHES

Required Opening Dimensions				
Angle ø	30°		45°	
	A	B	A	B
6"	11 3/4	38	11 3/4	27 7/16
7"	12 3/4	40	12 3/4	28 7/8
8"	13 3/4	42	13 3/4	30 1/4

Anchor Plate (EAP)

It is used to connect EXCEL Chimney to an appliance, masonry fireplace or heater.

Anchor Plate Dampers (EAPD, EAPD2)

Combines the anchor plate with a heavy gauge stainless steel damper to simplify masonry fireplace construction, reduces installation cost and provides a superior seal.

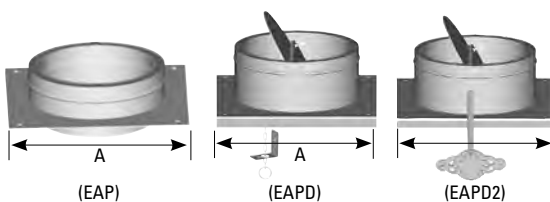

INCHES

Dimensions		
Code	Diameter	A
EAP	5	12" X 12
EAP - EAPD - EAPD2	6	12" X 12
EAP - EAPD - EAPD2	7	13" X 13
EAP - EAPD - EAPD2	8	14" X 14

Hardware Kit (HK)



Includes over 50 pieces of exclusive hardware for EXCEL installations - carriage bolts, thumbscrews, wingnuts and washers.

Flue Extension (EX)

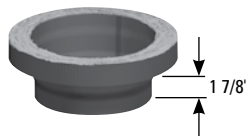

The flue extension fastens to the bottom of the first chimney length with three screws. It makes it possible to connect a stove pipe, or other type of connector, to the chimney. It is sometimes used to connect an EXCEL chimney directly to an appliance. The flue extension is designed to fit a variety of stove pipes. However, due to variations from one manufacturer to another, some modifications may be required in the field.

Locking Band (ELB)



EXCEL insulated components are designed to be fastened together with the stainless steel screws provided with each part. In some cases, it may be desirable to install a locking band for aesthetic purposes. The locking band is designed to overlap the two beads immediately above and below the chimney joint. Fastens with a 1/4" bolt. All three screws are required even when the ELB is installed.

Gable End Guide (EGEG)

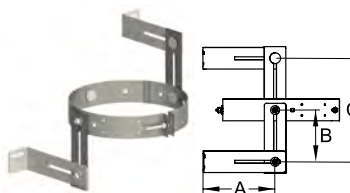

The purpose of the Gable End Guide is to assist in the stabilization of chimney as it passes the gable end of a home. The EGEG has adjustable arms to fit up to a 12/12 pitch. It is important to note the EGEG is a guide and it does NOT replace a support. Utilizes universal band to fit 6, 7 and 8" Chimneys.

INCHES

Dimensions						
Code	A min	B min	C min	A max	B max	C max
XM-EGEG	2 3/4	1 1/2	3	6 3/4	4 3/4	9 1/2

Roof Brace (ERB, ESRB)



Stainless steel roof brace poles (ESRB) are now available; the roof brace is used to provide lateral support for a chimney which extends more than 5 feet above a roof. The roof brace utilizes a universal band to fit 6, 7 and 8 inch chimneys. The arms on the roof brace telescope from 5 ft. to 9 ft. long.

Roof Brace Stiffener (ERBS)



Prevents roof brace poles bending under the weight of snow. Recommended for metal roofs.

Adjustable Stud Support (EAS)

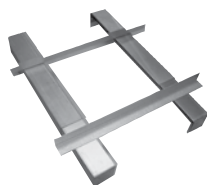

Allows you to install a round or square support (ERDS, ES & ESS) without using wood framing. The maximum support capacity is 30 feet of chimney. The maximum joist spacing is 24" center to center.

Snow-Wedge (ESW)



For roof pitches of 4/12 to 12/12.

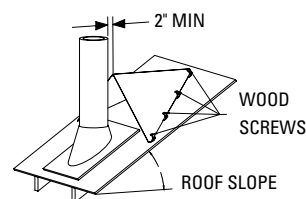

Wall Channel (EWC)



The wall channel enables a wall support or wall band to be fastened solidly to the framing when the framing centers do not line up with the chimney opening. The wall channel is 24" long.

Universal Vinyl Siding Trim (EVT)



This piece comes as two sections of galvanized metal. There are tabs cut into the strips that allow for easy bending at key points. Assembling these brackets will create a vinyl siding trim for any size of wall thimble in the wood, pellet or gas venting products.

Rain Caps

(ERC, EDRC, ERCS, ERCW, ERCB, ERRC)



Regular Rain Cap (ERC)



Rain Cap Deluxe (EDRC)

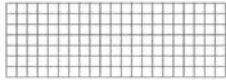

Spark Screen (ERCS)



Rain/Wind Shield (ERCW)



Rain Cap Base (ERCB)

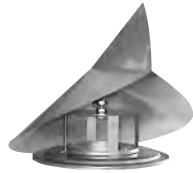

Revolving Rain Cap (ERRC)

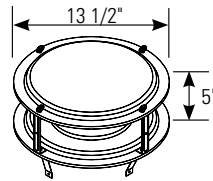

All EXCEL chimneys must be installed with an EXCEL rain cap (any model) to prevent water from entering the chimney.

ERC: The regular rain cap is made from .016" thick type 304 stainless steel and carries a one year warranty.

EDRC: The deluxe cap is made from .025" thick type 304 stainless steel and carries a **lifetime 100% full replacement warranty.**

ERCS: An optional stainless steel spark screen is available for installations where sparks can pose a safety problem.

ERCW: The optional wind and rain shield improves draft by up to 40% in windy conditions and is very effective at preventing wind driven rain from entering the chimney. It bolts to the existing holes in either the regular or deluxe cap.

ERCB: The rain cap base is designed to cover the end of the chimney in applications where a rain cap is not practical but it does not keep rain from entering the chimney.

ERRC: The revolving rain cap helps to prevent the entry of wind driven rain and helps to prevent wind induced downdrafts.

Flashings

(EF, ESF)

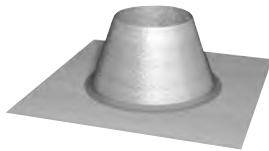

Flat Flashing (EF)

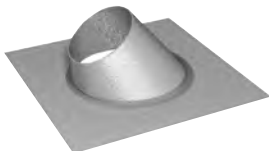
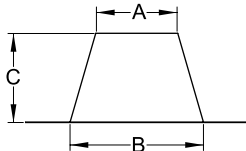

Adjustable Flashing (EFA, EFB, EFC)

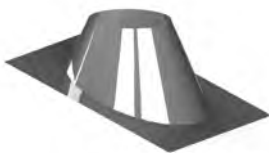
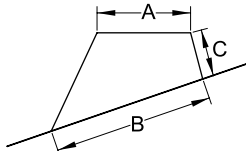

Stainless Steel Flashing (ESF)

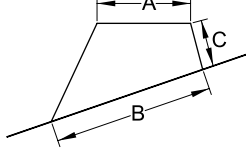

These flashings are made from either galvalume steel, which is considerably more corrosion resistant than galvanized, or from stainless steel for applications where maximum corrosion resistance is desired. They are made to cover the entire range of roof pitches.

INCHES

Flashing Dimensions							
Pitch	Flue I.D.	Galvalume	Stainless	Base W x L	A	B	C
Flat - 2/12	5"	5EF	5ESF	20 x 20	7 3/8	12	8
	6"	6EF	6ESF	24 x 24	8 3/8	14 1/16	8
	7"	7EF	7ESF	24 x 24	9 3/8	14 1/8	8
	8"	8EF	8ESF	24 x 24	10 3/8	16	8
1/12 - 7/12	5"	5EFA	5ESFA	20 x 20	7 3/8	12 5/8	3 3/4
	6"	6EFA	6ESFA	24 x 24	8 3/8	13 7/8	3 3/4
	7"	7EFA	7ESFA	24 x 24	9 3/8	14 1/4	3 3/4
8/12 - 12/12	5"	5EFB	5ESFB	24 x 28	7 3/8	17 1/16	3 3/4
	6"	6EFB	6ESFB	24 x 26	8 3/8	16 1/2	3 3/4
	7"	7EFB	7ESFB	24 x 28	9 3/8	18 1/16	3 3/4
	8"	8EFB	8ESFB	26 x 30	10 3/8	19 7/8	3 3/4
12/12 - 21/12	5"	5EFC	5ESFC	24 x 34	7 3/8	21	7 3/4
	6"	6EFC	6ESFC	24 x 40	8 3/8	23 3/16	7 3/4
	7"	7EFC	7ESFC	26 x 41	9 3/8	25 1/16	7 3/4
	8"	8EFC	8ESFC	26 1/2 x 43	10 3/8	27 1/4	7 3/4

All Flashings include a Storm Collar

Flashing	Storm Collar included	Material
EF	ESC	Galvalume
EFA	ESC	Galvalume
EFB	ESC	Galvalume
EFC	ESC	Galvalume
ESF	ESSC	Stainless
ESFA	ESSC	Stainless
ESFB	ESSC	Stainless
ESFC	ESSC	Stainless

Metal Roof Flashings

(EMF)

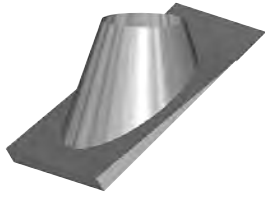

"US Patent 7114301,
Can Patent 2460044"

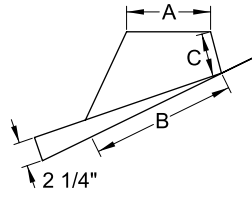

These flashings are specifically designed for metal roofs and greatly simplify metal roof installations. They are made from galvalume steel only. Due to the raised lip at the bottom edge of the Metal Roof Flashing, it cannot be installed on a roof pitch less than 3/12.

INCHES

Flashing Dimensions						
Pitch	Flue I.D.	Code	Base W x L	A	B	C
3/12 - 7/12	5"	5EMFA	24 3/4 x 21 3/4	7 3/8	12 9/16	3 3/4
	6"	6EMFA	24 3/4 x 21 3/4	8 3/8	13 13/16	3 3/4
	7"	7EMFA	24 3/4 x 21 3/4	9 3/8	14 1/8	3 3/4
	8"	8EMFA	24 3/4 x 23 3/4	10 3/8	15 5/16	3 3/4
8/12 - 12/12	5"	5EMFB	25 15/16 x 25 3/4	7 3/8	17 1/16	3 3/4
	6"	6EMFB	24 3/4 x 23 3/4	8 3/8	16 7/16	3 3/4
	7"	7EMFB	26 15/16 x 26 1/4	9 3/8	18 1/16	3 3/4
	8"	8EMFB	27 5/16 x 27 15/16	10 3/8	19 3/4	3 3/4
12/12 - 21/12	5"	5EMFC	26 3/4 x 31 3/4	7 3/8	21	7 13/16
	6"	6EMFC	26 3/4 x 37 3/4	8 3/8	23 3/16	7 13/16
	7"	7EMFC	36 3/4 x 38 3/4	9 3/8	25 1/16	7 13/16
	8"	8EMFC	26 3/4 x 40 3/4	10 3/8	27 1/4	7 13/16
All Flashings include a Storm Collar						
Flashing	Storm Collar included		Material			
EMFA	ESC		Galvalume			
EMFB	ESC		Galvalume			
EMFC	ESC		Galvalume			

Flexible Base Flashings

(ELFA, ELFB, ELFC)

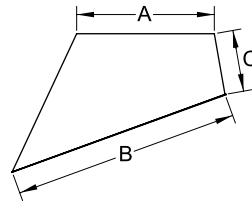

The flexible base flashing combines a stainless steel cone with a flexible lead base which can be easily formed on site to match virtually any roof profile. It was designed for masonry tile roofs but can be used wherever a flexible base is required except for metal roofs.

INCHES

Flashing Dimensions						
Pitch	Flue I.D.	Code	Base W x L	A	B	C
1/12 - 7/12	6"	6ELFA	13 1/8 x 13 7/8	8 3/8	13 13/16	3 3/4
	7"	7ELFA	13 1/2 x 14 1/4	9 3/8	14 1/8	3 3/4
	8"	8ELFA	14 1/2 x 15 3/8	10 3/8	15 5/16	3 3/4
8/12 - 12/12	6"	6ELFB	13 3/4 x 16 1/2	8 3/8	16 7/16	3 3/4
	7"	7ELFB	15 x 18 1/16	9 3/8	18 1/16	3 3/4
	8"	8ELFB	16 1/16 x 19 7/8	10 3/8	19 3/4	3 3/4
12/12 - 21/12	6"	6ELFC	13 15/16 x 23 3/16	8 3/8	23 3/16	7 13/16
	7"	7ELFC	15 x 25 1/16	9 3/8	25 1/16	7 13/16
	8"	8ELFC	16 3/8 x 27 1/4	10 3/8	27 1/4	7 13/16
All Flashings include a Storm Collar						
Flashing	Storm Collar included		Material			
ELFA	ESSC		Stainless			
ELFB	ESSC		Stainless			
ELFC	ESSC		Stainless			

Vented Flashings

(EVF, EVFA, EVFB, EVFC)

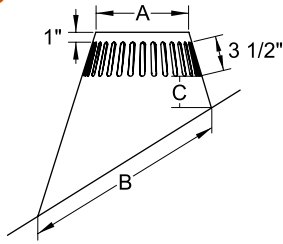

All Flashings include a Storm Collar

Flashing	Storm Collar included	Material
EVF	EVSC	Galvalume
EVFA	EVSC	Galvalume
EVFB	EVSC	Galvalume
EVFC	EVSC	Galvalume

Vented Flashings are required in certain applications where additional airflow is required.

INCHES

Flashing Dimensions						
Pitch	Flue I.D.	Code	Base W x L	A	B	C
Flat - 2/12	6"	6EVF	24 x 24	9 1/4	14 1/4	6
	7"	7EVF	26 x 26	10 1/4	15 1/4	6
	8"	8EVF	26 x 26	11 1/4	16 1/4	6
1/12 - 7/12	6"	6EVFA	26 x 26	9 1/4	14 13/16	6
	7"	7EVFA	26 x 26	10 1/4	15 15/16	6
	8"	8EVFA	26 x 26	11 1/4	17 1/16	6
8/12 - 12/12	6"	6EVFB	28 x 28	9 1/4	20 5/16	6
	7"	7EVFB	28 x 28	10 1/4	21 13/16	6
	8"	8EVFB	30 x 30	11 1/4	23 3/8	6
12/12 - 21/12	6"	6EVFC	28 x 40	9 1/4	26 13/16	7
	7"	7EVFC	29 x 41	10 1/4	28 5/16	7
	8"	8EVFC	30 x 43	11 1/4	30 1/16	7

Ventilated Chase Cone

(EVCC)

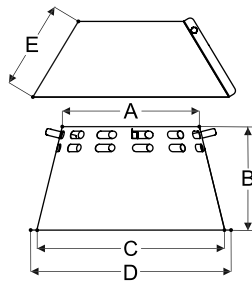

EVCC Ventilated Chase Cone

Designed to be mounted to custom chase top covers where the chimney is enclosed in a chase and the appliance requires a vented flashing. This vented cone provides the ventilation required without the cumbersome flashing base. This makes it easy to meet the vented flashing requirements, even with a custom chase top cover. Extra wide storm collar included.

INCHES

EVCC Dimensions						
Code	Flue I.D.	A	B	C	D	E
EVCC	6"	10 1/2"	7 7/8"	14 1/4"	15 1/4"	7"
	7"	11 1/2"	7 7/8"	15 1/4"	16 1/4"	7"
	8"	12 1/2"	7 7/8"	16 1/4"	17 1/4"	7"

Adjustable Peak Flashing

(EFP)

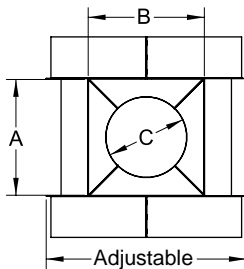
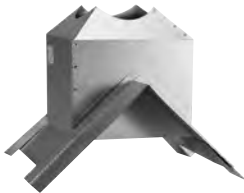

The adjustable peak flashing is designed to be used when the chimney passes through the peak of the home. It will fit any peak between 2/12 and 12/12.

INCHES

Flashing Dimensions					
Pitch	Flue I.D.	Code	A	B	C
2/12 - 12/12 Peak	6"	6EFP	12	12 3/16	8 3/8
	7"	7EFP	13	13 3/16	9 3/8
	8"	8EFP	14	14 3/16	10 3/8

All Flashings include a Storm Collar

Flashing	Storm Collar included	Material
EFP	ESC	Galvalume

Storm Collar

(ESC, ESQSC, EVSC)



ESC



ESQSC



EVSC

These storm collars fit 6, 7 and 8 inch EXCEL chimneys. To form an attic insulation shield assembly in an insulated space, use a storm collar in combination with a support box or radiation shield. The ESQSC is required to form an attic insulation shield on a Square Support (ESS), all other supports and radiation shields can use either collar. If installing 5" EXCEL, use the storm collar for EXCELDirect (TM-SC). Use the EVSC Storm Collar for vented flashing.

Roof Radiation Shield

(ERRS)

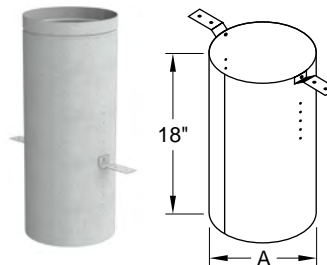

The roof radiation shield is required with some roof support and outside chase installations. Position of the mounting brackets is adjustable for roof pitch. Radiation Shields do NOT reduce chimney clearance. Always maintain 2" clearance to chimney through radiation shields.

INCHES

Roof Radiation Shield Dimensions	
Code	Diameter
6ERRS	10"
7ERRS	11"
8ERRS	12"

Radiation Shield (ERS)

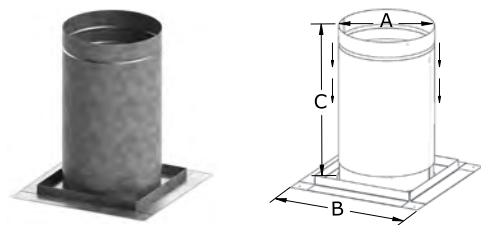

The radiation shield protects combustible framing in the floor or ceiling adjacent to the chimney and also acts as a firestop spacer. When the chimney passes through the radiation shield into an insulated space a universal storm collar must also be installed to prevent the entry of insulation. Radiation Shields do NOT reduce chimney clearance. Always maintain 2" clearance to chimney through radiation shields.

INCHES

Code	Dimensions			
	A	B	C	Framing
5ERS	10 1/2	16 X 16	15 3/4 - 28	12 x 12
6ERS	10 1/2	16 X 16	15 3/4 - 28	12 x 12
7ERS	11 1/2	16 X 16	15 3/4 - 28	13 x 13
8ERS	12 1/2	16 X 16	15 3/4 - 28	14 x 14

Storm collar (ESC) ordered separately.

Radiation Shield for Cathedral Ceiling (ERSC)

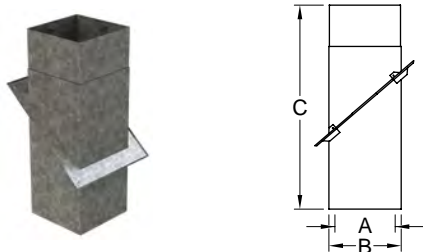

For installations where EXCEL chimney extends through a pitched ceiling. The firestop trim is adjustable to accommodate any pitch and has spacers to ensure that proper clearances are met.

In Canada, this part can be used in combination with factory built fireplaces only. For woodstove installations in Canada, the Attic Radiation Shield for Cathedral Ceilings (ERSCA) is required in combination with a Radiation Shield Tube.

Radiation Shields do NOT reduce chimney clearance. Always maintain 2" clearance to chimney through radiation shields.

INCHES

Code	Dimensions			
	A	B	C	Framing
6ERSC	8 1/4	10 1/4	24-38	12 x 12
7ERSC	9 1/4	11 1/4	24-38	13 x 13
8ERSC	10 1/4	12 1/4	24-38	14 x 14



Canadian Components:

The following components are for Canadian installations only and are not available in the USA.

Attic Radiation Shields

(ERSA)

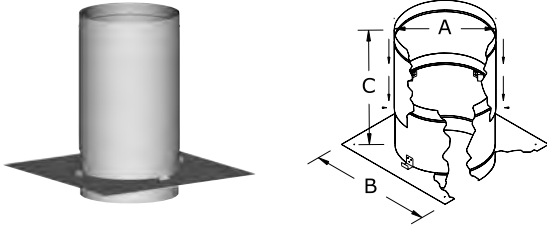

The radiation shield protects combustible framing in the floor or ceiling adjacent to the chimney and also acts as a firestop spacer. When the chimney passes through the radiation shield into an insulated space a universal storm collar must be installed on top of the ERSA to prevent the entry of insulation. The ERSA has a flange on the bottom to fasten the radiation shield tube. Radiation Shields do NOT reduce chimney clearance. Always maintain 2" clearance to chimney through radiation shields.

INCHES

Dimensions			
Code	A	B	C
5ERSA	Ø 10 1/2	16 X 16	13 3/4 - 26
6ERSA	Ø 10 1/2	16 X 16	13 3/4 - 26
7ERSA	Ø 11 1/2	16 X 16	13 3/4 - 26
8ERSA	Ø 12 1/2	16 X 16	13 3/4 - 26

Canada Only, not available in USA

Attic Radiation Shield for Cathedral Ceiling

(ERSCA)

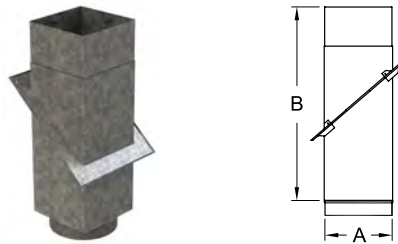

Similar to the Attic Radiation Shield (ERSA), only this component is designed for freestanding woodstove installations where insulated chimney passes through a cathedral ceiling. The ERSCA has a flange at its base to connect a Radiation Shield Tube. Radiation Shields do NOT reduce chimney clearance. Always maintain 2" clearance to chimney through radiation shields.

INCHES

Dimensions		
Code	A	B
6ERSCA	10 5/8	24 - 38
7ERSCA	11 5/8	24 - 38
8ERSCA	12 5/8	24 - 38

Canada Only, not available in USA

Radiation Shield Tubes

(ERST, ERSF & ERSF10)

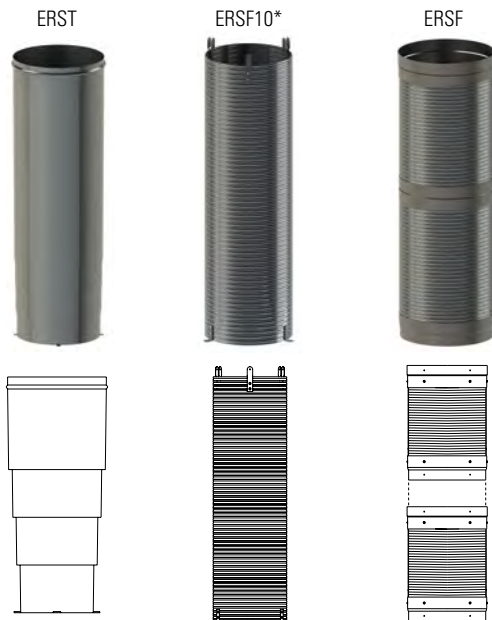

The radiation shield tube is only used where the chimney is enclosed in the interior of the building (e.g. between the basement ceiling and the attic). It is not required in the attic or on exterior chase installations. It is not required when EXCEL is installed on a fireplace, gas or oil appliance. The ERST or ERSF10 are for straight installations, the ERSF is used when an offset is required in the chimney. Radiation Shields do NOT reduce chimney clearance. Always maintain 2" clearance to chimney through radiation shields.

***ERSF10 does not include a Square Support Adapter (ESQSA); please order one separately for square support installations.**

INCHES

ERST Dimensions [†]			
Chimney	Diameter	Min. Length	Max. Length
6" Ø	9 3/4 - 10 3/4	32 1/4	98 1/4
7" Ø	10 3/4 - 11 3/4	32 1/4	98 1/4
8" Ø	11 3/4 - 12 3/4	32 1/4	98 1/4

ERSF10 Dimensions [†]			
Chimney	Inside diameter	Min. Length	Max. Length
6" Ø	9 3/4	36	120
7" Ø	10 3/4	36	120
8" Ø	11 3/4	36	120

ERSF Dimensions [†]			
Chimney	Inside diameter	Min. Length	Max. Length
6" Ø	9 3/4	45	137 1/2
7" Ø	10 3/4	45	137 1/2
8" Ø	11 3/4	45	137 1/2

[†]Canada Only, not available in USA

EXCEL Offset Tables

Use this table if you are not installing an adjustable length between the elbows.

LENGTH BETWEEN OFFSETS	15° Elbows		30° Elbows		45° Elbows	
	RISE	OFFSET	RISE	OFFSET	RISE	OFFSET
5 INCH Ø						
NO LENGTH	9 1/4	1 1/4	10 1/2	2 3/4	11 1/4	4 3/4
6" Length	13 1/4	2 1/4	14 1/4	5	14 1/4	7 3/4
12" Length	19	3 3/4	19 1/4	8	18 1/2	12
18" Length	25	5 1/2	24 1/2	11	22 3/4	16 1/4
24" Length	30 3/4	7	29 3/4	14	27	20 1/2
36" Length	38 1/2	10	33 3/4	20	35 1/2	29
48" Length	53 3/4	13 1/4	50 1/2	26	44	37 1/2
48" + 12"	63 3/4	15 3/4	59 1/2	31	51 1/4	44 3/4
48" + 18"	69 1/2	17 1/2	64 1/2	34	55 1/2	49
48" + 24"	75 1/4	19	69 3/4	37	59 3/4	53 1/4
48"+24"+12"	85 1/4	21 1/2	78 3/4	42 1/4	67	60 1/2
48" + 48"	98 1/2	25 1/4	90 1/2	49	76 3/4	70
6 INCH Ø						
NO LENGTH	9 1/2	1 1/4	11	3	12	5
6" Length	13 1/2	2 1/4	14 3/4	5	15	8
12" Length	19 1/4	4	19 3/4	8	19 1/4	12 1/4
18" Length	25 1/4	5 1/2	25	11	23 1/2	16 1/2
24" Length	31	7	30 1/4	14	27 3/4	20 3/4
36" Length	42 1/2	10	40 3/4	20	36 1/4	29 1/4
48" Length	54	13 1/4	51	26	44 3/4	37 3/4
48" + 12"	64	15 3/4	60	31 1/4	52	45
48" + 18"	69 3/4	17 1/2	65	34 1/4	56 1/4	49 1/4
48" + 24"	75 1/2	19	70 1/4	37 1/4	60 1/2	53 1/2
48"+24"+12"	85 1/2	21 3/4	79 1/4	42 1/4	67 3/4	60 3/4
48" +48"	98 3/4	25 1/4	91	49 1/4	77 1/2	70 1/2
7 INCH Ø						
NO LENGTH	9 3/4	1 1/4	11 1/2	3	12 3/4	5 1/4
6" Length	13 3/4	2 1/2	15 1/4	5 1/4	15 3/4	8 1/4
12" Length	19 1/2	4	20 1/4	8 1/4	20	12 1/2
18" Length	25 1/2	5 1/2	25 1/2	11 1/4	24 1/4	16 3/4
24" Length	31 1/4	7	30 3/4	14 1/4	28 1/2	21
36" Length	42 3/4	10 1/4	41 1/4	20 1/4	37	29 1/2
48" Length	54 1/2	13 1/4	51 1/2	26 1/4	45 1/2	38
48" + 12"	64 1/4	16	60 1/2	31 1/4	52 3/4	45 1/4
48" + 18"	70	17 1/2	65 1/2	34 1/4	57	49 1/2
48" + 24"	75 3/4	19	70 3/4	37 1/4	61 1/4	53 3/4
48"+24"+12"	85 3/4	21 3/4	79 3/4	42 1/2	68 1/2	61
48" + 48"	99	25 1/4	91 1/2	49 1/4	78 1/4	70 3/4
8 INCH Ø						
NO LENGTH	10	1 1/4	12	3 1/4	13 1/2	5 1/2
6" Length	14	2 1/2	15 3/4	5 1/4	16 1/2	8 1/2
12" Length	19 3/4	4	20 3/4	8 1/4	20 3/4	12 3/4
18" Length	25 3/4	5 1/2	26	11 1/4	25	17
24" Length	31 1/2	7	31 1/4	14 1/4	29 1/4	21 1/4
36" Length	43	10 1/4	41 3/4	20 1/4	37 3/4	29 3/4
48" Length	54 3/4	13 1/4	52	26 1/4	46 1/4	38 1/4
48" + 12"	64 1/2	16	61	31 1/2	53 1/2	45 1/2
48" + 18"	70 1/4	17 1/2	66	34 1/2	57 3/4	49 3/4
48" + 24"	76 1/4	19	71 1/4	37 1/2	62	54
48"+24"+12"	86	21 3/4	80 1/4	42 1/2	69 1/4	61 1/4
48" + 48"	99 1/4	25 1/4	92	49 1/2	79	71

All measurements are in inches

Use this table when an 18 inch adjustable length is required.

LENGTH BETWEEN OFFSETS	15° Elbows		30° Elbows		45° Elbows	
	RISE	OFFSET	RISE	OFFSET	RISE	OFFSET
5 INCH Ø						
6" Length	23 - 28 3/4	5 - 6 1/2	22 3/4 - 28	10 - 13	21 1/2 - 25 3/4	14 3/4 - 19
12" Length	28 3/4 - 34 1/2	6 1/2 - 8	28 - 33 1/4	13 - 16	25 3/4 - 30	19 - 23 1/4
18" Length	34 1/2 - 40 1/4	8 - 9 1/2	33 1/4 - 38 1/2	16 - 19	30 - 34 1/4	23 1/4 - 27 1/2
24" Length	40 1/4 - 46 1/4	9 1/2 - 11	38 1/2 - 43 1/2	19 - 22	34 1/4 - 38 1/2	27 1/2 - 31 3/4
36" Length	52 - 57 3/4	12 3/4 - 14 1/4	48 3/4 - 54	25 - 28	42 3/4 - 47	36 - 40 1/4
48" Length	63 1/2 - 69 1/4	15 3/4 - 17 1/4	59 1/4 - 64 1/2	31 - 34	51 1/4 - 55 1/4	44 1/2 - 48 3/4
48" + 12"	73 1/2 - 79 1/4	18 1/2 - 20	68 - 73 1/4	36 - 39	58 1/4 - 62 1/2	51 3/4 - 56
48" + 18"	79 1/4 - 85	20 - 21 1/2	73 1/4 - 78 1/2	39 - 42	62 1/2 - 66 3/4	56 - 60 1/4
48" + 24"	85 - 90 3/4	21 1/2 - 23	78 1/2 - 83 3/4	42 - 45	66 3/4 - 71	60 1/4 - 64 1/2
48"+24"+12"	95 - 100 3/4	24 1/4 - 25 3/4	87 1/4 - 92 1/2	47 1/4 - 50 1/4	74 - 78 1/4	67 1/2 - 71 3/4
48" + 48"	108 1/4 - 114	27 3/4 - 29 1/4	99 1/4 - 104 1/2	54 - 57	83 3/4 - 88	77 1/4 - 81 1/2
6 INCH Ø						
6" Length	23 1/4 - 29	5 - 6 1/2	23 1/4 - 28 1/2	10 - 13	22 1/4 - 26 1/2	15 - 19 1/4
12" Length	29 - 34 3/4	6 1/2 - 8	28 1/2 - 33 3/4	13 - 16	26 1/2 - 30 1/2	19 1/4 - 23 1/2
18" Length	34 3/4 - 40 1/2	8 - 9 1/2	33 3/4 - 39	16 - 19	30 1/2 - 34 3/4	23 1/2 - 27 3/4
24" Length	40 1/2 - 46 1/2	9 1/2 - 11 1/4	39 - 44	19 - 22	34 3/4 - 39	27 3/4 - 32
36" Length	52 1/4 - 58	12 3/4 - 14 1/4	49 1/4 - 54 1/2	25 - 28	43 1/4 - 47 1/2	36 1/4 - 40 1/2
48" Length	63 3/4 - 69 1/2	15 3/4 - 17 1/4	59 3/4 - 65	31 - 34	51 3/4 - 56	44 3/4 - 49
48" + 12"	73 3/4 - 79 1/2	18 1/2 - 20	68 1/2 - 73 3/4	36 1/4 - 39 1/4	59 - 63 1/4	52 - 56 1/4
48" + 18"	79 1/2 - 85 1/4	20 - 21 1/2	73 3/4 - 79	39 1/4 - 42 1/4	63 1/4 - 67 1/2	56 1/4 - 60 1/2
48" + 24"	85 1/4 - 91	21 1/2 - 23	79 - 84 1/4	42 1/4 - 45 1/4	67 1/2 - 71 3/4	60 1/2 - 64 3/4
48"+24"+12"	95 1/4 - 101	24 1/4 - 25 3/4	87 3/4 - 93	47 1/4 - 50 1/4	74 3/4 - 79	67 3/4 - 72
48" +48"	108 1/2 - 114 1/4	27 3/4 - 29 1/4	99 3/4 - 105	54 1/4 - 57 1/4	84 1/2 - 88 3/4	77 1/2 - 81 3/4
7 INCH Ø						
6" Length	23 1/2 - 29 1/4	5 - 6 1/2	23 3/4 - 29	10 1/4 - 13 1/4	22 3/4 - 27	15 1/4 - 19 1/2
12" Length	29 1/4 - 35	6 1/2 - 8	29 - 34 1/4	13 1/4 - 16 1/4	27 - 31 1/4	19 1/2 - 23 3/4
18" Length	35 - 40 3/4	8 - 9 1/2	34 1/4 - 39 1/2	16 1/4 - 19 1/4	31 1/4 - 35 1/2	23 3/4 - 28
24" Length	40 3/4 - 46 3/4	9 1/2 - 11 1/4	39 1/2 - 44 1/2	19 1/4 - 22 1/4	35 1/2 - 39 3/4	28 - 32 1/4
36" Length	52 1/2 - 58 1/4	12 3/4 - 14 1/4	49 3/4 - 55	25 1/4 - 28 1/4	44 - 48 1/4	36 1/2 - 40 3/4
48" Length	64 - 69 3/4	15 3/4 - 17 1/2	60 1/4 - 65 1/2	31 1/4 - 34 1/4	52 1/2 - 56 3/4	45 - 49 1/4
48" + 12"	74 - 79 3/4	18 1/2 - 20	69 - 74 1/4	36 1/4 - 39 1/4	59 3/4 - 64	52 1/4 - 56 1/2
48" + 18"	79 3/4 - 85 1/2	20 - 21 1/2	74 1/4 - 79 1/2	39 1/4 - 42 1/4	64 - 68 1/4	56 1/2 - 60 3/4
48" + 24"	85 1/2 - 91 1/4	21 1/2 - 23 1/4	79 1/2 - 84 3/4	42 1/4 - 45 1/4	68 1/4 - 72 1/2	60 3/4 - 65
48"+24"+12"	95 1/2 - 101 1/4	24 1/4 - 25 3/4	88 1/4 - 93 1/2	47 1/2 - 50 1/2	75 1/2 - 79 3/4	68 - 72 1/4
48" + 48"	108 3/4 - 114 1/2	27 3/4 - 29 1/4	100 1/4 - 105 1/2	54 1/4 - 57 1/4	85 1/4 - 89 1/2	77 3/4 - 82
8 INCH Ø						
6" Length	23 3/4 - 29 1/2	5 - 6 1/2	24 1/4 - 29 1/2	10 1/4 - 13 1/4	23 1/2 - 27 3/4	15 3/4 - 20
12" Length	29 1/2 - 35 1/4	6 1/2 - 8	29 1/2 - 34 3/4	13 1/4 - 16 1/4	27 3/4 - 32	20 - 24 1/4
18" Length	35 1/4 - 41	8 - 9 3/4	34 3/4 - 40	16 1/4 - 19 1/4	32 - 36 1/4	24 1/4 - 28 1/2
24" Length	41 - 47	9 3/4 - 11 1/4	40 - 45	19 1/4 - 22 1/4	36 1/4 - 40 1/2	28 1/2 - 32 3/4
36" Length	52 3/4 - 58 1/2	12 3/4 - 14 1/4	50 1/4 - 55 1/2	25 1/4 - 28 1/4	44 3/4 - 49	36 3/4 - 41
48" Length	64 1/4 - 70	15 3/4 - 17 1/2	60 3/4 - 66	31 1/4 - 34 1/4	53 1/4 - 57 1/2	45 1/4 - 49 1/2
48" + 12"	74 1/4 - 80	18 1/2 - 20	69 1/2 - 74 3/4	36 1/2 - 39 1/2	60 1/2 - 64 3/4	52 1/2 - 56 3/4
48" + 18"	80 - 85 3/4	20 - 21 3/4	74 3/4 - 80	39 1/2 - 42 1/2	64 3/4 - 69	56 3/4 - 61
48" + 24"	85 3/4 - 91 1/2	21 3/4 - 23 1/4	80 - 85 1/4	42 1/2 - 45 1/2	69 - 73 1/4	61 - 65 1/4
48"+24"+12"	95 3/4 - 101 1/2	24 1/4 - 25 3/4	88 3/4 - 94	47 1/2 - 50 1/2	76 1/4 - 80 1/2	68 1/4 - 72 1/2
48" + 48"	109 - 114 3/4	27 3/4 - 29 1/2	100 3/4 - 106	54 1/2 - 57 1/2	86 - 90 1/4	78 - 82 1/4

All measurements are in inches

ULTRABlack

DOUBLE WALL STOVE PIPE



ULTRABlack Technical Information

Certification

ULTRABlack has been tested and listed by Intertek Testing Services to ULC S641 standards.

Applications

ULTRABlack is designed to be used as a connector between a freestanding oil, wood or coal burning stove and a masonry or metal chimney. There are four primary advantages to ULTRABlack over single wall connector pipes:

- It offers reduced clearance to combustible materials.
- It is designed to last the lifetime of the stove and/or chimney system.
- It offers reduced creosote formation.
- It is certified for use with mobile home stoves.

Allowable Flue Gas Temperatures

Max Continuous	650°C (1200°F)
Brief Forced Firing	925°C (1700°F)
Tested To	1150°C (2100°F)

Clearance to Combustible Materials

ULTRABlack is certified for 6" clearance with the following exception. When ULTRABlack is used as the connector on a mobile home certified stove the clearance is determined by the installation instructions for the specific stove model being installed.

Construction

Flue: .016" stainless steel.

Casing: .019" satin coat steel. Satin coat is specifically designed to be painted.

Seam: Interior and exterior seams are seam welded.

Wall thickness: Approximately 3/8"

Paint: Forrest "Stove Bright" flat black

ULTRABlack Engineering and Design Considerations

Maximum allowable overall height:

There is no maximum requirement however, as a general guideline we recommend that the length of ULTRABlack not exceed 20 feet.

ULTRABlack assembles like a regular single wall stove pipe - no complicated, unsightly twist lock connectors or spot welds. There is no cutting required and all the screw holes are predrilled. Just put one piece on top of the other and screw together using the black oxide screws provided. Easily fits most stoves, including cast iron stoves and stoves with oval collars. ULTRABlack is approved for mobile home installation on most major stove brands, when installed with EXCEL insulated chimney. For mobile home installations follow the stove manufacturer's installation instructions.

EXCEL ULTRABlack

Fully Shielded Stove pipe with smooth, clean lines.

- Requires just 6" clearance to combustibles in all diameters - even when installed in a corner, or parallel with a ceiling*.
- Has a smooth, clean appearance to compliment any stove installation.
- Maximizes flue gas temperature, ensuring good draft.
- Minimizes creosote buildup.

* Some stoves may require greater clearances.



ULTRABlack Product Descriptions

Lengths (UB5F, UB1F, UB18F, UB2F & UB3F)

Lengths are available in 5", 12", 18", 24" and 36".

Adjustable Lengths (UBAF)

Adjustable Lengths combine a 36" length and a 36" slip length in one box. The UBAF fits all brands of insulated chimney and most brands of wood burning stoves without a stove or chimney adapter. A UBTC trim collar is included with the UBAF.

Slip Lengths (UB6SF, UB1SF & UB18SF)

Slip Lengths slide over a regular straight length allowing you to adjust the overall length of a straight run without cutting. The minimum adjustment can be reached only if the length used below the slip length is long enough to accept it.

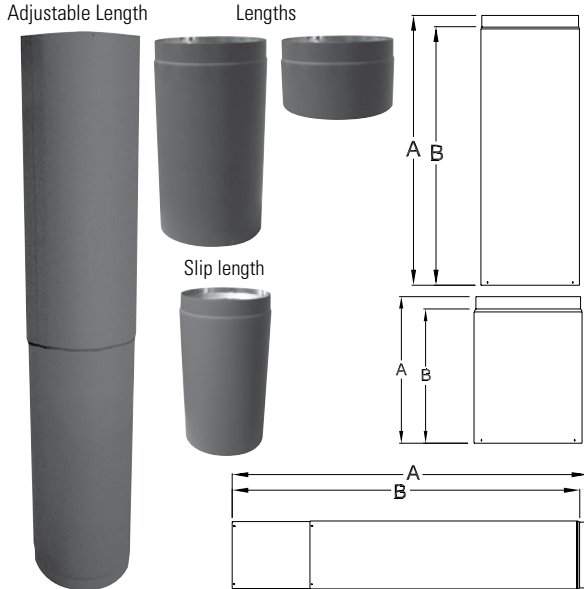

INCHES

Length Dimensions (6-7-8")		
Code	A	B
6-7-8 UB5F	5	4
6-7-8 UB1F	12	11
6-7-8 UB18F	18	17
6-7-8 UB2F	24	23
6-7-8 UB3F	36	35

INCHES

Slip Length Dimensions				
Code	A MIN.	A MAX.	B MIN.	B MAX.
UB6SF	2	6	1	5
UB1SF	2	12	1	11
UB18SF	2	18	1	17

INCHES

Adjustable Length Dimensions				
Code	A MIN.	A MAX.	B MIN.	B MAX.
6UBAF	40	68	39	67
7UBAF	40	68	39	67
8UBAF	40	68	39	67

Tees (UBT)

Combines a 90° transition with a clean out. Includes a tee cap (SE-ØSWTP).

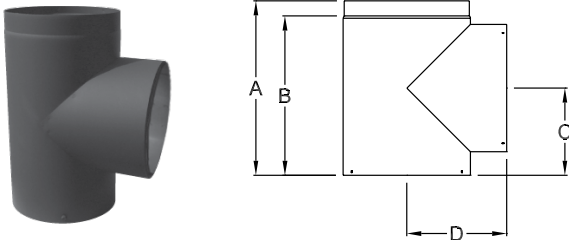

INCHES

Dimensions				
Code	A	B	C	D
6UBT	12	11	6	5 7/8
7UBT	12	11	6	6 3/8
8UBT	12	11	6	6 7/8

Elbows

(UB30, UB45 & UB90)

Are available in 30°, 45° and 90° (15° in 6" only).

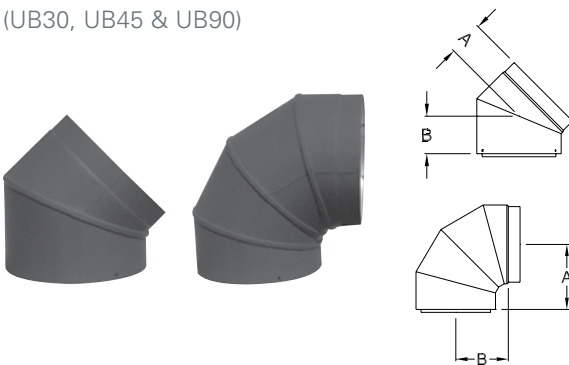

INCHES

Dimensions (30°, 45°, 90°)		
Code	A	B
6UB15	1 3/4	2
6UB30	2 5/16	2 9/16
7UB30	2 7/16	2 11/16
8UB30	2 9/16	2 13/16
6UB45	2 3/4	3
7UB45	2 15/16	3 3/16
8UB45	3 1/8	3 3/8
6UB90	5 9/16	4 1/2
7UB90	6 1/16	5
8UB90	6 9/16	5 1/2

Reducers

(UBR)

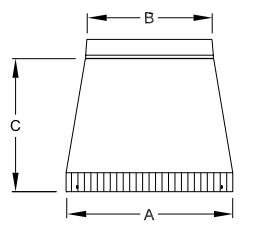

Large end crimped/male end

Designed to reduce the diameter of a system to accommodate a range of flue sizes, appliances and installations. *Note: Decreasing chimney diameter even 1" can have a serious negative impact of chimney performance. Be careful to use these components only when appropriate.*

INCHES

Dimensions			
Code	A	B	C
UBR76	7	6	7
UBR86	8	6	7
UBR87	8	7	7

Increasesers

(UBI)

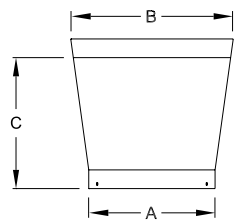

Small end male

Designed to increase the diameter of a system to accommodate a range of flue sizes, appliances and installations. *Note: Increasing chimney diameter can reduce draft and increase creosote formation. Be careful to use these components only when appropriate.*

INCHES

Dimensions			
Code	A	B	C
UBI56	5	6	7
UBI67	6	7	7
UBI68	6	8	7
UBI78	7	8	7

Oval to Round Adapter

(UBORF)

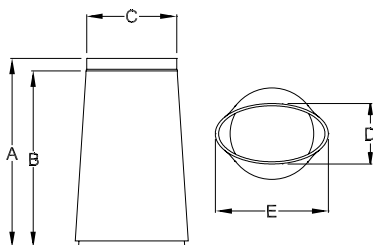

Adapters are designed to connect ULTRABlack to stoves with oval flue collars - such as a Vermont Castings Defiant Encore. Available in 8" oval to 8" round only.

INCHES

Dimensions (8" only)					
Code	A	B	C	D	E
8UBORF	18	17	8	5 3/4	10 3/4

Stove Adapters

(UBSE)

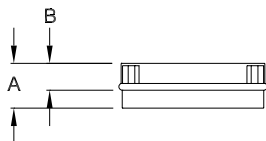

Primarily used with cast iron flue collars. Connect ULTRABlack to stoves with flue collars that do not project above the top of the stove. It can also be used to connect to stoves with irregular shaped or sized flue collars.

INCHES

Dimensions		
Code	A	B
6UBSE	2 1/2	1 1/2
7UBSE	2 1/2	1 1/2
8UBSE	2 1/2	1 1/2

Barometric Damper Adapter

(SWBA)

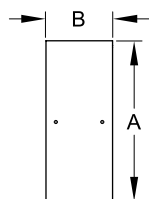

This adapter simplifies the connection between a barometric damper and an EXCELPrime or ULTRABlack tee.

INCHES

Dimensions		
Code	A	B
6SWBA	6 1/16	2 3/8
7SWBA	7 1/16	2 3/8
8SWBA	8 1/16	2 3/8

Masonry Adapter

(UBM)

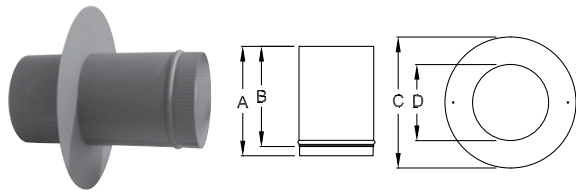

This part acts as a thimble sleeve to secure ULTRABlack or Prime to a masonry chimney that does not have a thimble or has an oversize one. *Note: ULTRABlack is not certified to pass through a combustible wall. An EXCELiner Insulated Thimble (ITH) must be used where there is a combustible wall between the stove and the masonry chimney. Flat trim collar included.*

INCHES

Dimensions				
Code	A	B	C	D
6UBM	11 7/8	10 7/8	12	6 1/8
7UBM	11 7/8	10 7/8	13	7 1/8
8UBM	11 7/8	10 7/8	14	8 1/8

Masonry Thimble Adapter

(UBMA)

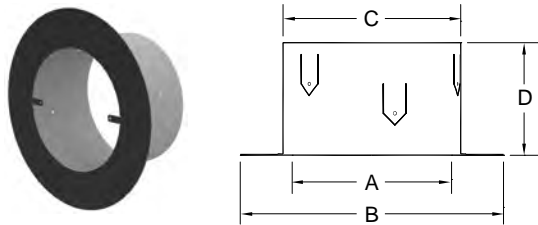

Connect ULTRABlack to a masonry chimney with an existing 8" thimble. *Note: ULTRABlack is not certified to pass through a combustible wall. An EXCELiner Insulated Thimble (ITH) must be used where there is a combustible wall between the stove and the masonry chimney.*

INCHES

Dimensions				
Code	A	B	C	D
6UBMA	6 7/8	11 1/8	7 1/2	4 3/4

Damper Section

(UBD)

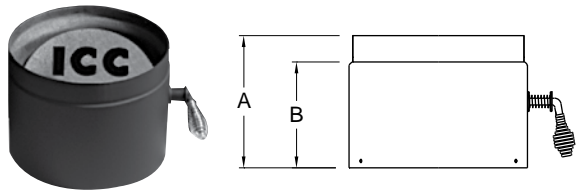

Butterfly type in line damper. They are recommended by some stove manufacturers to help control draft.

INCHES

Dimensions		
Code	A	B
UBD	5	4

Trim Collars

(UBTC)



Covers the crimped (top) end of ULTRABlack where it connects to the insulated chimney. A UBTC is included with every UBAF so they rarely need to be purchased separately.

INCHES

Dimensions	
Code	Dimensions
6UBTC	22 x 2
7UBTC	25 3/8 x 2
8UBTC	28 1/2 x 2

Conical Trim Ring

(UBTR)

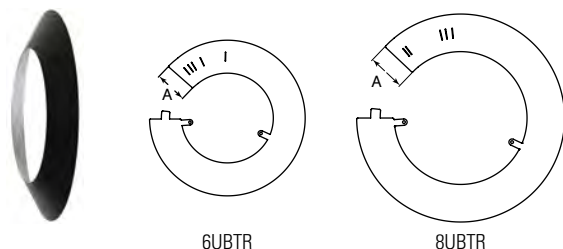

Adjustable to fit the exterior of regular ULTRABlack lengths and slip lengths. There are also slots to fit EXCELPPrime single wall pipe. Available in 6" or 8".

INCHES

Dimensions	
Code	A
UBTR	3"

ULTRABlack Offset Tables

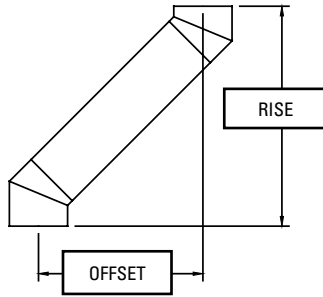

Use this table if you are not installing an adjustable length between the elbows.

LENGTH BETWEEN OFFSETS	15° Elbows		30° Elbows		45° Elbows	
	RISE	OFFSET	RISE	OFFSET	RISE	OFFSET
6 INCH Ø						
NO LENGTH	3 3/4	1/2	7 1/4	2	8 1/4	3 1/2
5" Length	7 1/2	1 1/2	10 1/2	4	11	6 1/4
6" Slip Length	7 1/2	1 1/2	-	-	-	-
12" Length	14 1/4	3 1/4	16 3/4	7 1/2	16	11 1/4
18" Length	20	4 3/4	21 3/4	10 1/2	20 1/4	15 1/2
24" Length	26	6 1/2	27	13 1/2	24 1/2	19 3/4
36" Length	37 1/2	9 1/2	37 1/2	19 1/2	33	28 1/4
UBAF min	42 1/4	10 3/4	-	-	-	-
UBAF max	69 1/4	18	-	-	-	-
7 INCH Ø						
NO LENGTH	3 3/4	1/2	7 3/4	2	9	3 3/4
5" Length	7 1/2	1 1/2	11	4	11 3/4	6 1/2
6" Slip Length	7 1/2	1 1/2	-	-	-	-
12" Length	14 1/4	3 1/4	17 1/4	7 1/2	16 3/4	11 1/2
18" Length	20	4 3/4	22 1/4	10 1/2	21	15 3/4
24" Length	26	6 1/2	27 1/2	13 1/2	25 1/4	20
36" Length	37 1/2	9 1/2	38	19 1/2	33 3/4	28 1/2
UBAF min	42 1/4	10 3/4	-	-	-	-
UBAF max	69 1/4	18	-	-	-	-
8 INCH Ø						
NO LENGTH	3 3/4	1/2	8 1/4	2 1/4	9 3/4	4
5" Length	7 1/2	1 1/2	11 3/4	4 1/4	12 1/2	7
6" Slip Length	7 1/2	1 1/2	-	-	-	-
12" Length	14 1/4	3 1/4	17 3/4	7 3/4	17 1/2	11 3/4
18" Length	20	4 3/4	23	10 3/4	21 3/4	16
24" Length	26	6 1/2	28 1/4	13 3/4	26	20 1/4
36" Length	37 1/2	9 1/2	38 1/2	19 3/4	34 1/2	28 3/4
UBAF min	42 1/4	10 3/4	-	-	-	-
UBAF max	69 1/4	18	-	-	-	-

All measurements are in inches

Use this table if you are installing an adjustable length between the elbows.

LENGTH BETWEEN OFFSETS	15° Elbows		30° Elbows		45° Elbows	
	RISE	OFFSET	RISE	OFFSET	RISE	OFFSET
6 INCH Ø						
NO LENGTH + UB6SF	7 1/2 - 7 1/2	1 1/2 - 1 1/2	8 1/4 - 10 1/2	2 3/4 - 4	9 1/4 - 11	4 1/2 - 6 1/4
5" Length + UB6SF	8 3/4 - 11 1/2	1 3/4 - 2 1/2	11 3/4 - 14	4 3/4 - 6	12 - 14	7 1/4 - 9 1/4
5" Length + UB12SF	14 1/4 - 17 1/4	3 1/4 - 4	16 3/4 - 19 1/4	7 1/2 - 9	16 - 18 1/4	11 1/4 - 13 1/2
12" Length + UB12SF	15 1/2 - 24	3 1/2 - 6	17 3/4 - 25 1/4	8 1/4 - 12 1/2	17 - 23	12 1/4 - 18 1/4
18" Length + UB12SF	21 1/4 - 29 3/4	5 1/4 - 7 1/2	23 - 30 1/2	11 1/4 - 15 1/2	21 1/4 - 27 1/4	16 1/2 - 22 1/2
24" Length + UB18SF	27 - 41 1/4	6 3/4 - 10 1/2	28 1/4 - 41	14 1/4 - 21 1/2	25 1/2 - 35 3/4	20 3/4 - 31
UBAF	-	-	41 3/4 - 66	22 - 36	36 1/2 - 56 1/4	31 3/4 - 51 1/2
UBAF + 18" Length	-	-	55 1/2 - 79 3/4	30 - 44	47 3/4 - 67 3/4	43 - 63
UBAF min + UB6SF	43 1/2 - 46 1/4	11 1/4 - 11 3/4	-	-	-	-
UBAF min + UB18SF	43 1/2 - 57 3/4	11 1/4 - 15	-	-	-	-
UBAF max + UB18SF	70 1/2 - 84 3/4	18 1/2 - 22 1/4	-	-	-	-
36" + 36" + 12" + UB18SF	83 1/4 - 97 1/2	21 3/4 - 25 1/2	78 1/4 - 91 1/4	43 1/4 - 50 1/2	66 1/2 - 76 3/4	61 3/4 - 72
36" + 36" + 24" + UB18SF	94 3/4 - 109	24 3/4 - 28 3/4	88 3/4 - 101 1/2	49 1/4 - 56 1/2	75 - 85 1/4	70 1/4 - 80 1/2
36" + 36" + 36" + UB18SF	106 1/4 - 120 1/2	28 - 31 3/4	99 1/4 - 112	55 1/4 - 62 1/2	83 1/2 - 93 3/4	78 3/4 - 89
7 INCH Ø						
NO LENGTH + UB6SF	7 1/2 - 7 1/2	1 1/2 - 1 1/2	8 3/4 - 11	2 3/4 - 4	10 - 11 3/4	4 3/4 - 6 1/2
5" Length + UB6SF	8 3/4 - 11 1/2	1 3/4 - 2 1/2	12 1/4 - 14 1/2	4 3/4 - 6	12 3/4 - 14 3/4	7 1/2 - 9 1/2
5" Length + UB12SF	14 1/4 - 17 1/4	3 1/4 - 4	17 1/4 - 19 3/4	7 1/2 - 9	16 3/4 - 19	7 1/2 - 13 3/4
12" Length + UB12SF	15 1/2 - 24	3 1/2 - 6	18 1/4 - 25 3/4	8 1/4 - 12 1/2	17 3/4 - 23 3/4	12 1/2 - 18 1/2
18" Length + UB12SF	21 1/4 - 29 3/4	5 1/4 - 7 1/2	23 1/2 - 31	11 1/4 - 15 1/2	22 - 28	16 3/4 - 22 3/4
24" Length + UB18SF	27 - 41 1/4	6 3/4 - 10 1/2	28 3/4 - 41 1/2	14 1/4 - 21 1/2	26 1/4 - 36 1/2	21 - 31 1/4
UBAF	-	-	42 1/4 - 66 1/2	22 - 36	37 1/4 - 57	32 - 51 3/4
UBAF + 18" Length	-	-	56 - 80 1/4	30 - 44	48 1/2 - 68 1/2	43 1/4 - 63 1/4
UBAF min + UB6SF	43 1/2 - 46 1/4	11 1/4 - 11 3/4	-	-	-	-
UBAF min + UB18SF	43 1/2 - 57 3/4	11 1/4 - 15	-	-	-	-
UBAF max + UB18SF	70 1/2 - 84 3/4	18 1/2 - 22 1/4	-	-	-	-
36" + 36" + 12" + UB18SF	83 1/4 - 97 1/2	21 3/4 - 25 1/2	78 3/4 - 91 3/4	43 1/4 - 50 1/2	67 1/4 - 77 1/2	62 - 72 1/4
36" + 36" + 24" + UB18SF	94 3/4 - 109	24 3/4 - 28 3/4	89 1/4 - 102	49 1/4 - 56 1/2	75 3/4 - 86	70 1/2 - 80 3/4
36" + 36" + 36" + UB18SF	106 1/4 - 120 1/2	28 - 31 3/4	99 3/4 - 112 1/2	55 1/4 - 62 1/2	84 1/4 - 94 1/2	79 - 89 1/4
8 INCH Ø						
NO LENGTH + UB6SF	7 1/2 - 7 1/2	1 1/2 - 1 1/2	9 1/4 - 11 3/4	3 - 4 1/4	10 1/2 - 12 1/2	5 - 7
5" Length + UB6SF	8 3/4 - 11 1/2	1 3/4 - 2 1/2	12 3/4 - 15 1/4	5 - 6 1/4	13 1/2 - 15 1/4	7 3/4 - 9 3/4
5" Length + UB12SF	14 1/4 - 17 1/4	3 1/4 - 4	17 3/4 - 20 1/4	7 3/4 - 9 1/4	17 1/2 - 19 1/2	7 3/4 - 14
12" Length + UB12SF	15 1/2 - 24	3 1/2 - 6	18 3/4 - 26 1/2	8 1/2 - 12 3/4	18 1/4 - 24 1/2	12 3/4 - 19
18" Length + UB12SF	21 1/4 - 29 3/4	5 1/4 - 7 1/2	24 - 31 3/4	11 1/2 - 15 3/4	22 1/2 - 28 3/4	17 - 23 1/4
24" Length + UB18SF	27 - 41 1/4	6 3/4 - 10 1/2	29 1/4 - 42	14 1/2 - 21 3/4	26 3/4 - 37 1/4	21 1/4 - 31 3/4
UBAF	-	-	43 - 67 1/4	22 1/4 - 36 1/4	38 - 57 3/4	32 1/4 - 52 1/4
UBAF + 18" Length	-	-	56 3/4 - 81	30 1/4 - 44 1/4	49 1/4 - 69	43 3/4 - 63 1/2
UBAF min + UB6SF	43 1/2 - 46 1/4	11 1/4 - 11 3/4	-	-	-	-
UBAF min + UB18SF	43 1/2 - 57 3/4	11 1/4 - 15	-	-	-	-
UBAF max + UB18SF	70 1/2 - 84 3/4	18 1/2 - 22 1/4	-	-	-	-
36" + 36" + 12" + UB18SF	83 1/4 - 97 1/2	21 3/4 - 25 1/2	79 1/2 - 92 1/4	43 1/2 - 50 3/4	67 3/4 - 78 1/4	62 1/4 - 72 3/4
36" + 36" + 24" + UB18SF	94 3/4 - 109	24 3/4 - 28 3/4	89 3/4 - 102 3/4	49 1/2 - 56 3/4	76 1/4 - 86 3/4	70 3/4 - 81 1/4
36" + 36" + 36" + UB18SF	106 1/4 - 120 1/2	28 - 31 3/4	100 1/4 - 113	55 1/2 - 62 3/4	84 3/4 - 95 1/4	79 1/4 - 89 1/2

All measurements are in inches

REVOLUTIONARY NEW STOVE PIPE

THE ONLY STOVE PIPE LISTED FOR **4" CLEARANCE** WITH SHIELDING



EXCELPrime

SINGLE WALL STOVE PIPE



EXCELPrime Technical Information

Certification

EXCELPrime has been tested and listed by Intertek Testing Services

Applications

EXCELPrime is designed to be used as a connector between a freestanding oil, wood or coal burning stove and a masonry or metal chimney.

Allowable Flue Gas Temperatures

Max Continuous	650°C (1200°F)
Brief Forced Firing	925°C (1700°F)
Tested To	1150°C (2100°F)

Clearance to Combustible Materials

EXCELPrime is certified for 18" clearance to combustible materials or otherwise specified by appliance manufacturer instructions.

With the addition of a listed EXCELPrime Heat Shield, the clearance can be reduced to:

6" dia.	- 4" clearance from the shield
7" & 8" dia.	- 6" clearance from the shield

Construction

Single Wall: 24ga steel

Seam: Laser seam welded

Paint: Forrest "Stove Bright" flat black

EXCELPrime Engineering and Design Considerations

Maximum allowable overall height:

EXCELPrime must not exceed 10 feet in length and a maximum of two 90-degree elbows are permitted.

To assemble EXCELPrime, ensure that the shrunken end is facing down. Place one length on top of another and screw them together using the screws provided. There is no cutting required and all the screw holes are predrilled. EXCELPrime easily fits most stoves including cast iron stoves and stoves with oval collars.

EXCELPrime

Single wall stove pipe with smooth, clean lines.

- Heavy wall, 24ga steel.
- Laser welded to be perfectly round and does not require assembly like snap lock pipes.
- Has a 5 year, no questions asked replacement warranty.
- Without shielding, EXCELPrime requires 18" clearance to combustibles in all diameters.
- With an EXCELPrime UL Listed Heat Shield, clearance to combustibles can be reduced to 4" from the exterior of the shield for 6" EXCELPrime or 6" clearance for 7 & 8" EXCELPrime.



Length (SW1, SW18, SW2, SW3, SW4)

Slip Length (SW1S)

Adjustable Length (SWA)

Lengths are available in 12", 18", 24", 36" and 48" lengths; 6", 7" and 8" diameter.

Slip Length will slide into a regular straight length allowing you to adjust the overall length of a straight run without cutting. The minimum adjustment can be reached only if the length used below the slip length is long enough to accept it.

Adjustable Lengths combine a 36" length and a 36" slip length in one box. The SWA provides enough range that it is often the only component required for vertical installations.

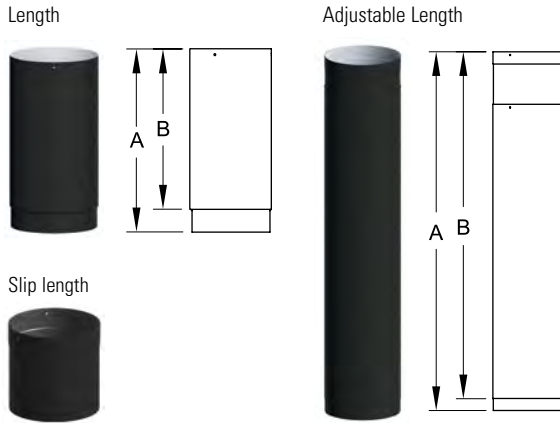

Length Dimensions		
Code	A	B
SW1	12	10 5/8
SW18	18	16 5/8
SW2	24	22 5/8
SW3	36	34 5/8
SW4	48	46 5/8

Slip Length Dimensions		
Code	Min. Installed Length	Max. Installed Length
SW1S	1 3/8	10 5/8
SW6S	1 3/8	4 5/8

Adjustable Length Dimensions				
Code	A MIN.	A MAX.	B MIN.	B MAX.
SWA	40	68	38 5/8	66 5/8

Damper Section (SWD)

Acts as a 5" length and has a butterfly type incorporated damper. In the closed position, the damper is still 20% open so as not to completely block the chimney.

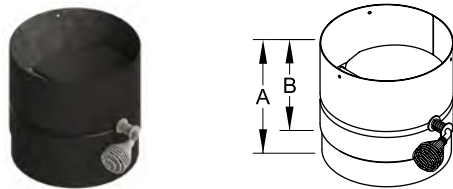

Dimensions		
Code	A	B
SWD	6	4 5/8

Tee (SWT)

Combines a 90° transition with a clean out. Tee Cap (SWTP) **not included**.

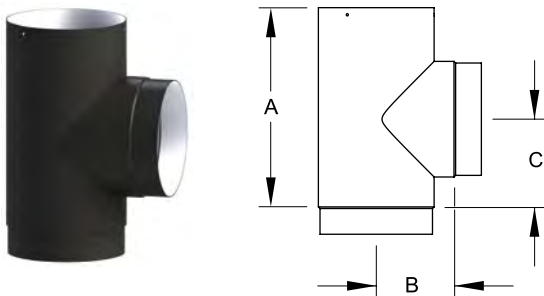

Dimensions			
Code	A	B	C
6SWT	10 5/8	4 1/4	4 3/4
7SWT	10 5/8	4 3/4	4 3/4
8SWT	10 5/8	5 1/4	4 3/4

Tee Cap (SWTP)

Caps off the open portion of a Tee.



Dimensions		
Code	A	B
6SWTP	6	1
7SWTP	7	1
8SWTP	8	1

Elbow

(SW45, SW90)

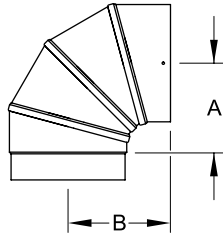
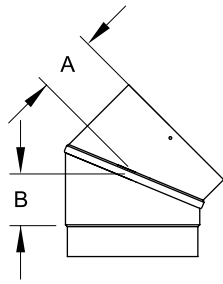

Are available in 45° and 90°

INCHES

Dimensions		
Code	A	B
6SW45	2 5/8	2 1/4
7SW45	2 7/8	2 1/4
8SW45	3 1/8	2 1/2
6SW90	4 3/4	5 3/8
7SW90	5 1/4	5 7/8
8SW90	5 3/4	6 3/8

Slip Elbow 90°

(SW90S)

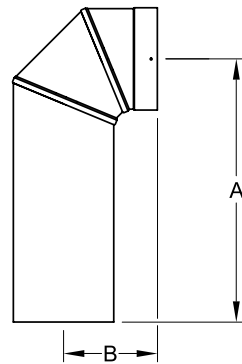

Combines a 90° elbow and a slip length in one piece.

INCHES

Dimensions			
Code	A max.	A min.	B
6SW90S	19 3/4	4	5 5/8
7SW90S	19 3/8	4 1/2	6 1/8
8SW90S	19 1/8	5	6 5/8

Clean Out Elbow 90°

(SW90C)

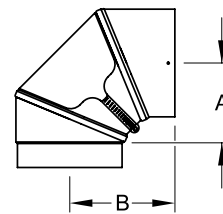

Incorporates an easily removable inspection port that is large enough for a chimney brush.

INCHES

Dimensions		
Code	A	B
6SW90C	4 5/8	6
7SW90C	5 1/8	6 1/2
8SW90C	5 5/8	7

Adjustable Elbow 90°

(SWA90)

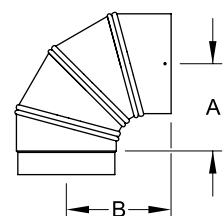

The angle of this elbow is variable between 90° and straight. Patent Pending.

INCHES

Dimensions		
Code	A	B
6SWA90	5 3/8	6 3/8
7SWA90	5 7/8	6 7/8
8SWA90	6 3/8	7 3/8

Increaser (SWSI)

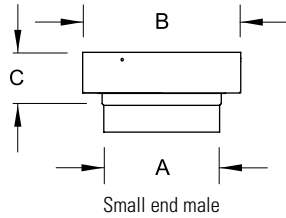

Designed to increase the diameter of a system to accommodate a range of flue sizes, appliances and installations. *Note: Increasing chimney diameter can reduce draft and increase creosote formation. Be careful to use these components only when appropriate.*

INCHES

Dimensions			
Code	A	B	C
SWSI67	6	7 1/8	2 5/8
SWSI68	6	8 1/8	2 5/8
SWSI46	3 7/8	6 1/8	2 1/4

Reducer (SWSR)

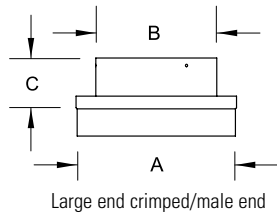

Designed to reduce the diameter of a system to accommodate a range of flue sizes, appliances and installations. *Note: Decreasing chimney diameter even 1" can have a serious negative impact on chimney performance. Be careful to use these components only when appropriate.*

INCHES

Dimensions			
Code	A	B	C
SWSR76	7	6 1/8	2 1/2
SWSR87	8	7 1/8	2 1/2
SWSR86	8	6 1/8	2 1/2

Oval to Round Adapter (8SWOR)

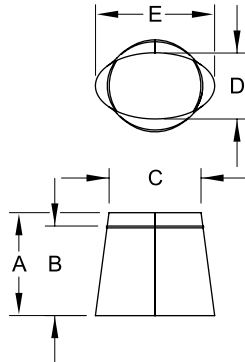

Connects EXCELPrime to stoves with oval flue collars. Available in 8" only.

INCHES

Dimensions					
Code	A	B	C	D	E
8SWOR	9	7 7/8	8	5 3/4	10 3/8

12" Slip Flue Extension (6SWEX)

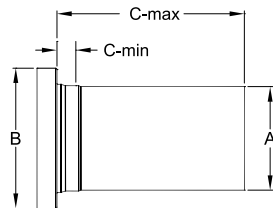

Can be used to replace the EXCEL Flue Extension (EX) in EXCELPrime installations. This 12" long version will slip into a standard length, eliminating the need for a slip length.

INCHES

Dimensions				
Code	A	B	C MIN.	C MAX.
6SWEX	5 7/8	8	1/2	10 - 3/4

Barometric Damper Adapter (SWBA)

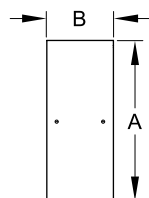

This adapter simplifies the connection between a barometric damper and an EXCELPrime or ULTRABlack tee.

INCHES

Dimensions		
Code	A	B
6SWBA	6 1/16	2 3/8
7SWBA	7 1/16	2 3/8
8SWBA	8 1/16	2 3/8

Masonry Adapter

(SWM)

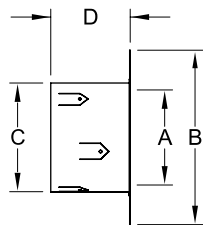

Connects 6" EXCELPrime to a 7" or 8" masonry chimney thimble. *Note: EXCELPrime is not certified to pass through a combustable wall. An EXCELiner Insulated Thimble (ITH, page 41) must be used where there is a combustable wall between the stove and the masonry chimney.*

Dimensions				
Code	A	B	C	D
6SWM	6 1/4	10 1/2	6 5/8	4 3/4

See 6UBM for use with 6" Masonry Chimney Thimbles

Masonry Plug

(SWMP)

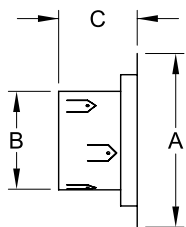

Plugs the opening into an existing masonry chimney that had been previously used to vent another appliance. The Masonry Plug is capable of plugging a round opening up to 8" diameter and is lined with insulation to prevent cold drafts.

Dimensions			
Code	A	B	C
SWMP	10 1/2	5 7/8	4 3/4

Heat Shield

(SW1HS, SW2HS, SW3HS, SW45HS, SW90HS)

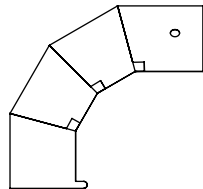
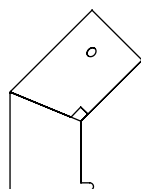
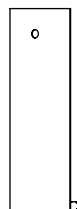

Reduces clearance required from combustable walls and ceilings. EXCELPrime heat shields are UL listed in combination with EXCELPrime only and will not reduce the clearance of other brands of stove pipe (each heatshield includes installed heatshield spacers). For other brands of single wall stove pipe, clearances will be reduced to those of an unlisted heat shield installation. Available in 12", 24", 36", 45° and 90° designs.

Clearance	
Diameter	Clearance to Combustibles from Shielding
6"	4"
7"	6"
8"	6"

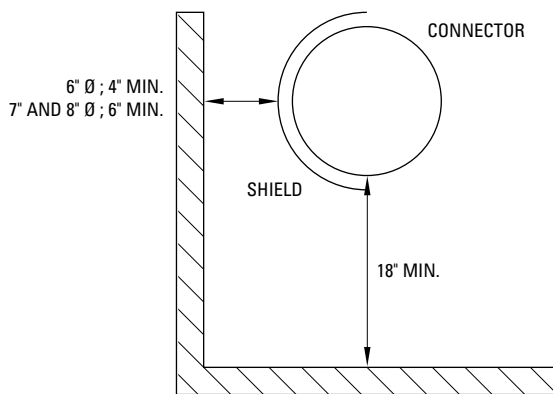

Heat Shield Spacer

(SWHSS)

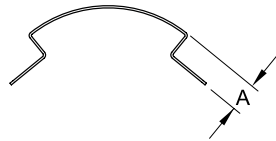

Used to maintain 7/8" spacing where shields do not overlap.

Dimensions	
Code	A
SWHSS	7/8

EXCELPrime Offset Tables

Use this table if you are not installing an adjustable length between the elbows.

LENGTH BETWEEN OFFSETS	45° Elbows	
	RISE	OFFSET
6 INCH Ø		
NO LENGTH	8 1/4	3 1/2
6" SLIP LENGTH	11 1/2	6 3/4
12" LENGTH	15 3/4	11
18" LENGTH	20	15 1/4
24" LENGTH	24 1/4	19 1/2
36" LENGTH	32 3/4	28
SWA min	35 3/4	30 3/4
SWA max	55 1/2	50 1/2
7 INCH Ø		
NO LENGTH	8 3/4	3 1/2
6" SLIP LENGTH	12	7
12" LENGTH	16 1/4	11 1/4
18" LENGTH	20 1/2	15 1/2
24" LENGTH	24 3/4	19 1/2
36" LENGTH	33 1/4	28
SWA min	36	31
SWA max	55 3/4	50 3/4
8 INCH Ø		
NO LENGTH	9 1/2	4
6" SLIP LENGTH MAX	12 3/4	7 1/4
12" LENGTH	17	11 1/2
18" LENGTH	21 1/4	15 3/4
24" LENGTH	25 1/2	20
36" LENGTH	34	28 1/2
SWA min	37	31 1/4
SWA max	56 3/4	51

All measurements are in inches

Use this table if you are installing an adjustable length between the elbows.

LENGTH BETWEEN OFFSETS	45° Elbows	
	RISE	OFFSET
6 INCH Ø		
NO LENGTH + L6S	- 11 1/2	- 6 3/4
12" LENGTH + L6S	16 3/4 - 19	12 - 14 1/4
12" LENGTH + L12S	- 23 1/4	- 18 1/2
18" LENGTH + L12S	21 - 27 1/2	16 1/4 - 22 3/4
24" LENGTH + L12S	25 1/4 - 31 3/4	20 1/2 - 27
18" + 12" LENGTH + L12S	28 1/2 - 35	23 3/4 - 30 1/4
36" LENGTH + L12S	33 3/4 - 40 1/4	29 - 35 1/2
SWA	36 1/2 - 55 1/2	31 3/4 - 50 1/2
7 INCH Ø		
NO LENGTH + L6S	- 12	- 7
12" LENGTH + L6S	17 1/4 - 19 1/2	12 - 14 1/2
12" LENGTH + L12S	- 23 3/4	- 18 3/4
18" LENGTH + L12S	21 1/2 - 28	16 1/4 - 23
24" LENGTH + L12S	25 3/4 - 32 1/4	20 1/2 - 27 1/4
18" + 12" LENGTH + L12S	29 - 35 1/2	23 3/4 - 30 1/2
36" LENGTH + L12S	34 1/4 - 40 3/4	29 - 35 1/2
SWA	37 - 55 3/4	32 - 50 3/4
8 INCH Ø		
NO LENGTH + L6S	- 12 3/4	- 7 1/4
12" LENGTH + L6S	18 - 20 1/2	12 1/2 - 14 3/4
12" LENGTH + L12S	- 24 3/4	- 19
18" LENGTH + L12S	22 1/4 - 28 3/4	16 3/4 - 23 1/4
24" LENGTH + L12S	26 1/2 - 33	21 - 27 1/2
18" + 12" LENGTH + L12S	29 3/4 - 36 1/2	24 1/4 - 30 3/4
36" LENGTH + L12S	35 - 41 1/2	29 1/2 - 36
SWA	38 - 56 3/4	32 1/4 - 51

All measurements are in inches

EASY TO INSTALL

EASY TO MAINTAIN

SUPERIOR QUALITY PRODUCT

Manufactured using Type 304 stainless steel, EXCELiner is listed to UL and ULC standards by Intertek Testing Services to be used as a liner in a new chimney or to reline an existing chimney. Designed to withstand chimney fires without damage and to facilitate installation, its perfectly round, smooth shape allows lengths to fit together effortlessly. Simply line up the pre-punched holes, fasten with the stainless steel rivets provided and you're done!

EXCELiner offers versatility and a cost-effective solution, with a large range of lengths, connections and diameters, making it an excellent option when used:

- to replace clay tile liners or to reline clay tile liners which have become cracked, misused, or had chimney fires;
- to improve the safety, performance and efficiency of wood or gas-burning stoves and fireplace inserts by reducing the chimney to the correct size for the appliance;
- to improve draft, reduce fuel consumption, and help to ensure consistent appliance operation;
- as the flue in a new masonry chimney or in an unlined chimney.



EXCELiner can be used in combination with EXCELFlex liner to install in difficult to maneuver places.



EXCELiner

RIGID LINER FOR MASONRY CHIMNEYS



EXCELiner Technical Information

Certification

EXCELiner is tested and listed by Intertek Testing Services to the following standards:

ULC S-635 - Standard for relining existing masonry chimneys in Canada.

ULC S-640 - Standard for liners for new masonry chimneys in Canada.

UL 1777 - Standard for liners in new and existing masonry chimneys in the USA.

The installation requirements vary depending on which standard your installation must meet, particularly with respect to the requirements for insulation and clearance from the liner. You must ensure that your EXCELiner is installed in accordance with your local building codes.

EXCELiner is available in 5", 5.5", 6", 7" and 8" diameters.

EXCELiner is certified for installation in combination with all certified brands of flexible chimney liner.

Applications

EXCELiner is certified as a chimney liner for use on appliances that burn:

- Wood
- Oil
- Natural or LP Gas

Allowable Flue Gas Temperatures

Max Continuous	650°C (1200°F)
Brief Forced Firing	925°C (1700°F)
Tested To	1150°C (2100°F)

Clearance to Combustible Materials

The clearance between EXCELiner and surrounding combustible and non-combustible materials varies with the type of installation. Please refer to the installation instructions for specific details for your application.

Construction

Single wall: .016" or .025" stainless steel (all tees are heavy gauge .025").

Seam: Continuous seam welded.

Insulation: Optional (required for some applications) Foil backed ceramic liner.

EXCELiner Engineering and Design Considerations

EXCELiner is a fast, cost effective solution to the following chimney situations:

To repair cracked or damaged clay tile liners. EXCELiner is designed and approved to replace clay tile liners which have become cracked from age, misuse, or chimney fires. EXCELiner can be used to reline structurally sound masonry chimneys where the liners have deteriorated due to chimney fires, spalled tiles, moisture damage or eroded mortar joints.

To improve the safety, performance and efficiency of wood or gas burning stoves and fireplace inserts. By reducing the chimney to the correct size for the appliance EXCELiner improves draft, reduces fuel consumption, and helps ensure consistent operation. There is less creosote formation in a properly sized flue which decreases the probability of a chimney fire.

EXCELiner is listed to UL and ULC standards by Intertek Testing Services to be used as stainless steel liner in a new chimney, instead of a clay tile liner. Unlike clay tile liners, EXCELiner can withstand chimney fires without damage and comes with a lifetime warranty.

EXCELiner is easier to clean

EXCELiner's smooth surface accumulates less creosote than a flexible liner and is much easier to clean.



EXCELiner has been tested and listed to the ULC S-635 ULC S-640 and UL 1777 chimney liner standards by INTERTEK.

EXCELiner Product Descriptions

Lengths

(LL4, LL3, LL2 & LL1)

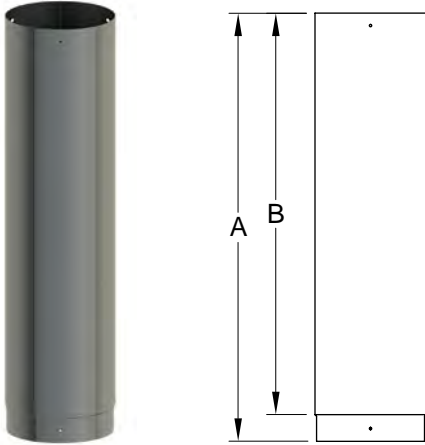

EXCELiner is available in 4', 3', 2' and 1' lengths. EXCELiner components fasten together with 100% stainless steel pop rivets which are supplied with the liner. The holes and slots for the rivets are factory pre-punched so no drilling is required. The male and female ends are hemmed to make the liner more rigid and reduce the likelihood of cutting yourself during installation.

EXCELiner is available in 5", 5.5", 6", 7" and 8" diameter.

Length Dimensions		
	A	B
LL1	11 5/8	10 1/4
LL2	23 5/8	21 1/4
LL3	35 1/2	33 1/8
LL4	47 1/2	45 1/8

INCHES

Slip Lengths

(LLA3 & LLA1)

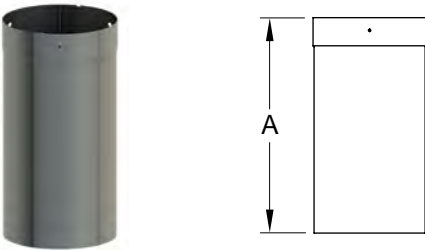

Slip lengths are available in 3' and 1' lengths. Slip lengths are used to adjust the length of the system without cutting. *Note: Slip lengths must be installed above a fixed length or they will not adjust. They should not be installed immediately above a tee or elbow.*

Dimensions		
Code	A MIN.	A MAX.
LLA1	1 3/8	11 5/8
LLA3	1 3/8	35 1/2

INCHES

Split Base Tees

(LT)

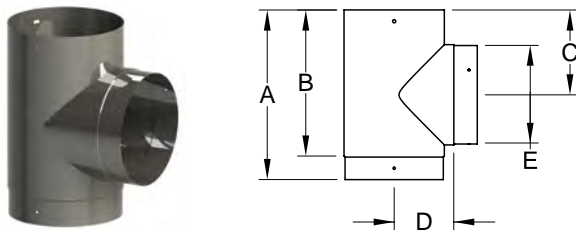

EXCELiner tees are made from .025" thick stainless steel. The removable snout is fastened to the body of the tee with heavy duty stainless steel screws. **All 5 1/2", and 6" tees have a 6" diameter snout so that they can connect to 6" smoke pipe without a reducer.** Tee Cap (LTC) not included.

Dimensions					
Code	A	B	C	D	E
5LT	9 3/8	8	4 5/8	3 1/8	4 7/8
55LT	9 7/8	8 3/8	4 7/8	3 3/8	5 7/8
6LT	10 3/8	9	5 1/8	3 5/8	5 7/8
7LT	11 3/8	10	5 5/8	4 1/8	6 7/8
8LT	12 3/8	11	6 1/8	4 5/8	7 7/8

INCHES

Adjustable Snout Tees

(LTA)

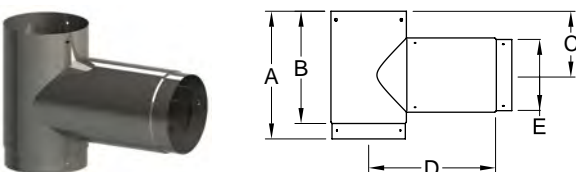

EXCELiner tees are made from .025" thick stainless steel. The LTA eliminates the difficult job of cutting and fastening a short horizontal length of liner in the breeching. **All 5 1/2", and 6" tees have a 6" diameter snout so that they can connect to 6" smoke pipe without a reducer.** Tee Cap (LTC) not included.

Dimensions						
Code	A	B	C	D MIN.	D MAX.	E
5LTA	9 3/8	8	4 5/8	9 5/8	15 3/4	4 7/8
55LTA	9 7/8	8 1/2	4 7/8	9 7/8	16	5 7/8
6LTA	10 3/8	9	5 1/8	10 1/8	16 1/4	5 7/8
7LTA	11 3/8	10	5 5/8	10 5/8	16 5/8	6 7/8
8LTA	12 3/8	11	6 1/8	11 1/8	17 1/8	7 7/8

INCHES

Twist Lock Tee

(LTL)

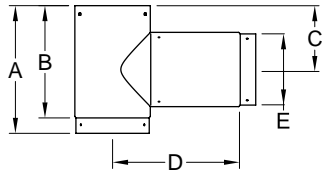

The Twist Lock Tee is ideal for tight installations. The telescopic snout connects to the body of the tee with a twist action and locks into place with fold over tabs.

INCHES

Dimensions						
Code	A	B	C	D MIN.	D MAX.	E
5LTL	10 1/4	8 7/8	5 1/8	9 3/4	15 7/8	4 7/8
55LTL	10 3/4	9 3/8	5 5/8	10	16 1/8	5 15/16
6LTL	11 1/4	9 7/8	5 5/8	10 1/4	16 3/8	5 7/8
7LTL	12 1/4	10 7/8	6 1/8	10 3/4	16 7/8	6 7/8
8LTL	13 1/4	11 7/8	7 1/8	11 1/4	17 3/8	7 7/8

Tee Cap

(LTC)

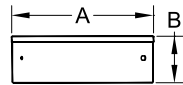

Blocks off the open portion of the tee.

INCHES

Dimensions		
Code	A	B
5LTC	5	1
55LTC	5 1/2	1
6LTC	6	1
7LTC	7	1
8LTC	8	1

Elbows

(LE30, LE45, LE90 & LEA90)

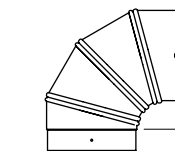
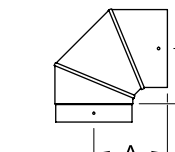
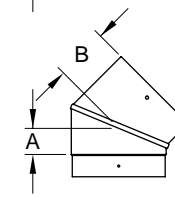
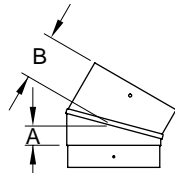

The elbows are used when a directional change is required (LEA90 can be adjusted).

INCHES

Dimensions		
Code	A	B
5LE30	1 1/4	2 5/8
55LE30	1 3/8	2 3/4
6LE30	1 3/8	2 7/8
7LE30	1 1/2	3
8LE30	1 5/8	3 1/8
5LE45	1 5/8	3
55LE45	1 3/4	3 1/8
6LE45	1 7/8	3 1/4
7LE45	2	3 1/2
8LE45	2 1/4	3 5/8
5LE90	5 1/4	3 7/8
55LE90	5 1/2	4 1/8
6LE90	5 3/8	4 3/8
7LE90	6 1/4	4 7/8
8LE90	6 3/4	5 3/8
5LEA90	5 7/8	4 1/2
55LEA90	6 1/8	4 3/4
6LEA90	6 3/8	5
7LEA90	6 7/8	5 1/2
8LEA90	7 3/8	6

Adjustable Flex Adapter Elbow

(LAF90)

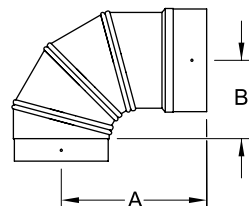

This adjustable elbow is designed for use during the installation of an insert. The angle of the elbow is adjustable to ease installation, and three tabs on the inside of the elbow help secure a flexible liner in place without tearing.

INCHES

Dimensions		
Code	A	B
5LAF90	8 1/2	4 1/2
55LAF90	8 3/4	4 3/4
6LAF90	9 1/4	5
7LAF90	9 3/4	5 1/2
8LAF90	10 1/4	6

Flex Liner Adapters

(LAF)

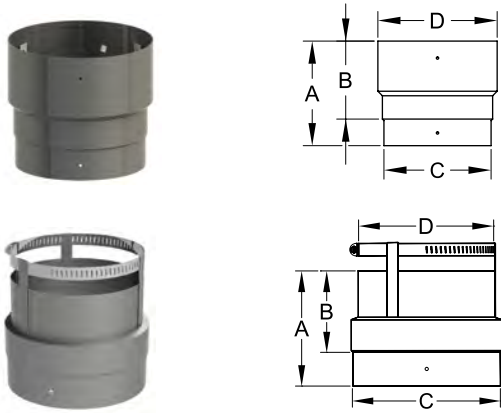

Note: The male end of EXCELiner will fit into most brands of stainless flex (except for some models of flex which are intentionally made undersize) so no adapter is generally required when the flex is installed below the rigid.

Can be used either as an appliance adapter for stainless flex or to connect rigid EXCELiner to flex. The 6LAF5 and 6LAF55 will connect an appliance with a 6" flue outlet to 5" or 5 1/2" flex liner respectively.

INCHES

Dimensions				
Code	A	B	C	D
4LAF	4 1/2	1 3/4	3 7/8	4 1/2
5LAF	5 3/4	4 1/4	4 7/8	5 1/2
55LAF	5 3/4	4 1/4	5 3/8	6
6LAF	5 3/4	4 1/4	5 7/8	6 1/2
7LAF	5 3/4	4 1/4	6 7/8	7 1/2
8LAF	5 3/4	4 1/4	7 7/8	8 1/2

Dimensions				
Code	A	B	C	D
6LAF5	4 5/8	3 1/4	5 7/8	5 1/2
6LAF55	3 3/8	1 3/4	5 7/8	6

Increases and Reducers

(LI & LR)

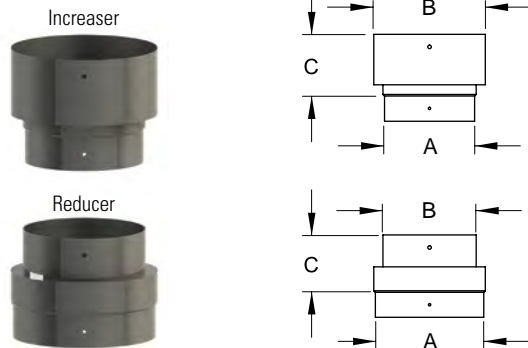

Designed to increase or reduce the size of an EXCELiner to accommodate a range of flue sizes, appliances and installations. Note: Increasing or decreasing chimney size can have a negative impact of chimney performance and safety. Use these components only when appropriate.

INCHES

Incraser Dimensions			
Code	A	B	C
LI56	4 7/8	6	3 1/4
LI556	5 3/8	6	3 1/4
LI67	5 7/8	7	3 1/4
LI78	6 7/8	8	3 1/4

Reducer Dimensions			
Code	A	B	C
LR65	5 7/8	5	3
LR655	5 7/8	5 1/2	3
LR76	6 7/8	6	3
LR87	7 7/8	7	3

Insulated Wall Thimbles

(ITH)

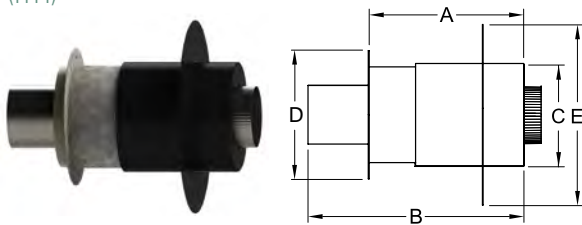

The ITH is tested and listed to connect through a combustible wall into a masonry chimney. It is adjustable to accommodate wall thickness up to 10" and can be combined with any UL listed liner system (ULC S-635, ULC S-640 or UL 1777). Not available in 5.5"

INCHES

Dimensions						
Code	A MIN.	A MAX.	B	C	D	E
5ITH	7 1/2	13	20	8 3/4	11	15 1/2
6ITH	7 1/2	13	20	9 3/4	12	17
7ITH	7 1/2	13	20	10 3/4	13	18 1/2
8ITH	7 1/2	13	20	11 3/4	14	20

ITH Extension

(ITHE)

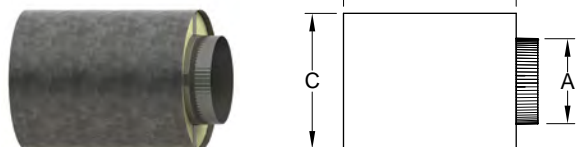

UL Listed extension for the Insulated Wall Thimble (ITH). Increases the total depth of the ITH to 24".

INCHES

Dimensions			
Code	A	B	C
5ITHE	4 7/8	13 1/2	8 7/16
6ITHE	5 7/8	13 1/2	9 7/16
7ITHE	6 7/8	13 1/2	10 7/16
8ITHE	7 7/8	13 1/2	11 7/16

Rain Caps

(LCR, LCD)

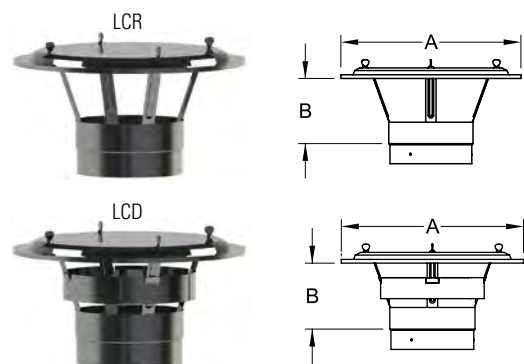

EXCELiner rain caps are made entirely of type 304 stainless steel. The top is held in place with four wing nuts on the regular (LCR) and deluxe (LCD) rain caps for easy removal and cleaning without the need to remove the rain cap itself. The deluxe cap has a stainless steel band.

Dimensions		
Code	A	B
5 LCR & LCD	13	3 7/8
55 LCR & LCD	13	4
6 LCR & LCD	13	4 1/8
7 LCR & LCD	13	4 1/4
8 LCR & LCD	13	4 3/8

Top Supports

(LSA, LSAL, LSAG & LSAGL)

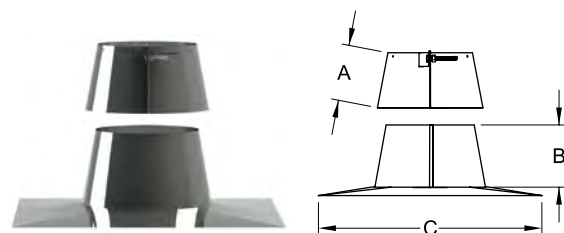

The top support is designed to seal off the top of the liner system and support the vertical liner. It is available in either stainless steel or galvalume. There are two base sizes available - 16" X 16" and 24" X 24".

Dimensions			
Code	A	B	C
LSA	4	4 1/2	16
LSAL	4	4 1/2	24
LSAG	4	4 1/2	16
LSAGL	4	4 1/2	24

Base Support

(LSB)



The base support is designed to seal and support a liner system. It is available in galvalume only. Support capacity 40'.

Offset Box

(FOB)

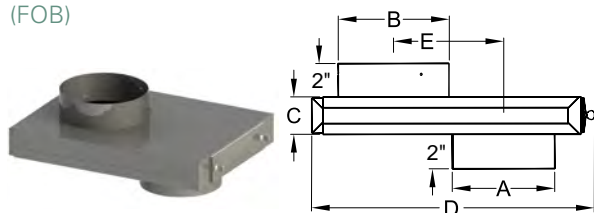

For tight insert installations that need to be offset quickly in order to align with the flue. The Offset Box is adjustable in length and has a clean-out port with removable thumb screws.

Dimensions							
Code	A	B	C	D MIN.	D MAX.	E MIN.	E MAX.
6FOB	5 7/8	6 3/8	2 1/8	15 5/8	20 5/8	6 3/8	10 5/8
8FOB	7 7/8	8 3/8	2 3/16	17 7/8	21 5/8	6 5/8	9 5/8

Model RIS

ALL FUEL, INSULATED CHIMNEY SYSTEM 10" - 24"



Model RIS Technical Information

Certification

Model RIS is tested and listed by Intertek Testing Services to the following standard:

UL 103HT – The standard for chimneys on gas, liquid and solid fuel-fired appliances in the USA.

CAN/ULC-S604 – The standard for chimneys on gas and liquid fuel-fired appliances in Canada.

CAN/ULC-S610 – The standard for solid fuel Factory-Built Fireplaces in Canada.

Applications

RIS chimney is suitable for use on appliances that burn:

- Wood
- Oil
- Coal
- Natural or LP Gas
- Charcoal

Model RIS is certified to vent wood burning stoves, fireplaces and residential furnaces. In addition, there are a number of RIS components specifically designed and certified to vent large open masonry fireplaces burning wood and/or gas. There are also specific components designed to extend masonry chimneys and repair earthquake damaged masonry chimneys.

Note for customers in Canada: RIS chimney is not certified to the CAN/ULC-S629 standard but is certified to CAN/ULC-S610 in combination with some solid fuel appliances (e.g. Renaissance Fireplaces). Only install RIS on wood fireplaces certified to CAN/ULC-S610 in combination with RIS or contact the appropriate authorities for approval, beforehand. ICC can provide complete engineering services (sizing, material selection, installation recommendations, drawings etc.) to assist you in obtaining approval. However, we can not guarantee that it will be accepted in all cases. If you have a large fireplace project you would like to quote on please be sure to contact us in advance so we can work with your local engineer, architect and building authority.

Allowable Flue Gas Temperatures

Max Continuous	540°C (1000°F)
Brief Forced Firing	760°C (1400°F)
Tested To	1150°C (2100°F)

Clearance to Combustible Materials

Model RIS is certified for 2" clearance to combustible materials.

Construction

Flue: .018" - .025", stainless steel.

Casing*: .018" - .025", stainless steel or .018" - .025" galvalume steel.

Seam: Interior and exterior seams are continuous seam welded.

Insulation: Thermoplus continuous blanket.

Wall thickness: 1"

See page 81 of this catalog for recommended chimney sizing for masonry fireplaces.

Note: There are some components of RIS chimney that are available in 10" and 12" diameter only. Some of these parts are designed for specific fireplaces which are not described in the catalog.

* See Lengths (RLL), for types of stainless steel by diameter.



Model RIS has been tested and listed to the UL 103HT chimney standards by INTERTEK.

Model RIS Product Descriptions

Lengths (RIL)

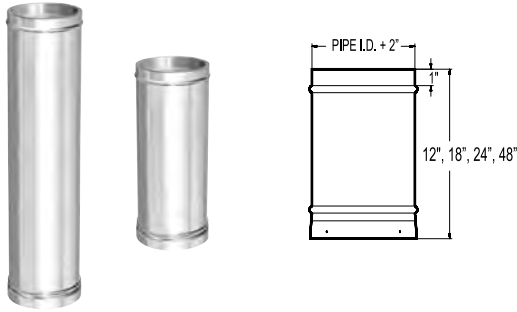

RIS is available in 12", 18", 24" and 48" lengths. Deduct 1 1/2" from overall length to determine the actual installed dimension.

Diameters 10" – 14" have a 430 stainless steel exterior like EXCEL.

Diameters 16" – 24" have either a galvalume or 304 stainless steel exterior.

Adjustable Lengths (RILA)

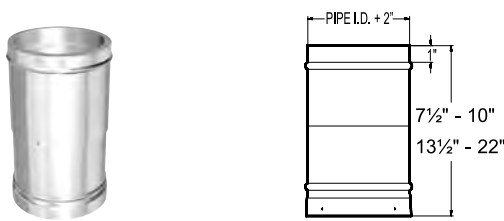

12" and 24" adjustable lengths are available. The 12" can be adjusted from 7 1/2" to 10". The 24" can be adjusted from 13 1/2" to 22". Deduct 1 1/2" from overall length to determine the actual installed length. *Note: Adjustable lengths must be installed above a fixed length or they will not work. They should not be installed immediately above a round or square support, tee or elbow.*

Insulated Tees (RIT)

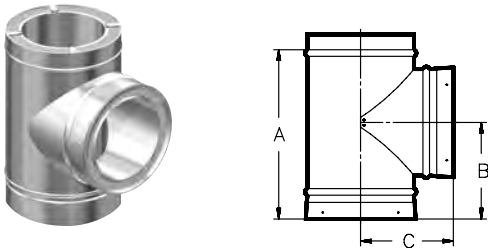

Designed to connect horizontal and vertical lengths of the chimney. Does not include a tee cap (RITC).

INCHES			
Dimensions			
PIPE I.D.	A	B	C
10	16 3/4	9	9
12	18 3/4	10	10
14	20 3/4	11	11
16	22 3/4	12	12
18	24 3/4	13	13
20	26 3/4	14	14
22	28 3/4	15	15
24	30 3/4	16	16

Elbows (RIE15, RIE30 & RIE45)

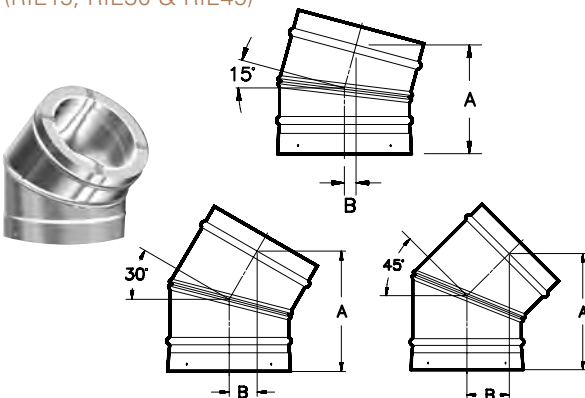

Used when a directional change is required. *Note: 45° elbows are approved for use in Canada only.*

INCHES						
Dimensions						
PIPE I.D.	15°		30°		45° CANADA ONLY	
	A	B	A	B	A	B
10	6 7/8	3/4	8 1/2	1 7/8	9 3/8	2 3/4
12	7 3/8	7/8	9	2	10	3 1/4
14	7 7/8	7/8	9 1/2	2 1/8	10 3/4	3 3/4
16	8 3/8	1	10	2 1/4	11 1/2	4 1/4
18	8 7/8	1	10 1/2	2 1/2	12 1/4	4 5/8
20	9 3/8	1 1/8	11	2 5/8	12 7/8	5 1/8
22	9 7/8	1 1/8	11 1/2	2 3/4	13 1/2	5 5/8
24	10 3/8	1 1/4	12	2 7/8	14 1/4	6

Chimney Top Damper

(RCTD)

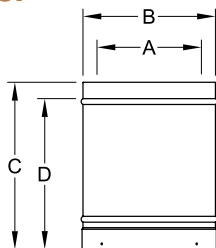

Currently available in 10" to 16" diameter only. Adding this "Top Damper" to a system seals it right at the top of the chimney. The "Chimney Top Damper" is placed directly below the cap and is designed to prevent any cold air infiltration into the house through the chimney. It functions on a chain that hangs down to the firebox and comes with 30 feet of cable.

INCHES

Dimensions				
Code	A	B	C	D
10RCTD	10	12	12	10 1/4
12RCTD	12	14	12	10 1/4

Radiation Shield

(RRS)

Used when the chimney passes through a combustible floor or ceiling. Radiation Shields do NOT reduce chimney clearance. Always maintain 2" clearance to chimney through radiation shields.

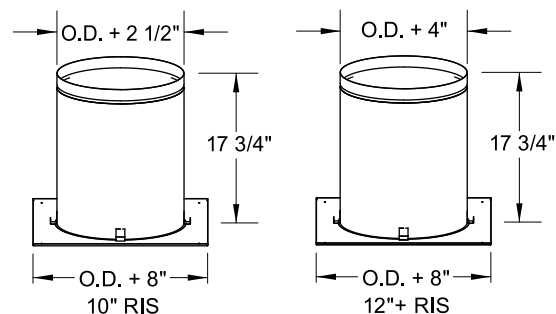

Anchor Plate

(RAP)

Is used to connect an appliance (such as a masonry fireplace or heater) to an RIS chimney.

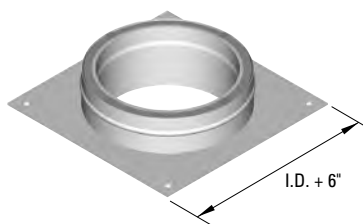

Anchor Plate Damper

(RAPD, RAPD2)

Combines the anchor plate with a heavy gauge stainless steel damper. The RAPD simplifies masonry fireplace construction, reduces installation cost and provides a superior seal. The RAPD comes with 6' stainless steel cable.

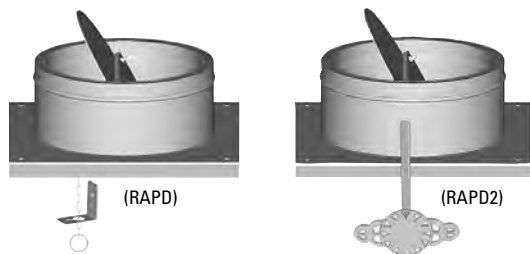

Rain Caps

(RRC, RDRC)

The RIS rain cap is constructed entirely of stainless steel. It is designed to provide good protection from wind and rain while being a small size and a low profile. The Deluxe Rain Cap is available in 10" and 12" diameters. An optional wind/rain shield is available in 10" - 24" diameter. An optional spark screen is available for installations where sparks can pose a safety problem.



Note: We do not recommend the use of untested, unlisted rain caps or shrouds. In some cases it is possible to create an unsafe installation simply by using an aftermarket shroud. If you choose to do so you must terminate the chimney with an ICC Rain Cap Base (RRCB). The RRCB closes off the top of the chimney to prevent moisture from entering the insulation.

INCHES

Rain Caps Dimensions		
PIPE I.D.	A	B
10	17	5
12	20 1/4	6
14	23 3/4	7
16	27 1/4	8
18	30 5/8	9
20	34	10
22	37 3/8	11
24	40 3/4	12

Spark Screen

(RRCFS)



Rain Cap Base

(RRCB)

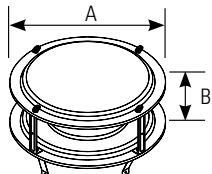

Roof Flashings

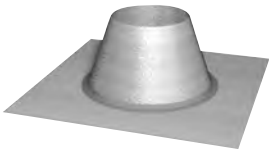

RF

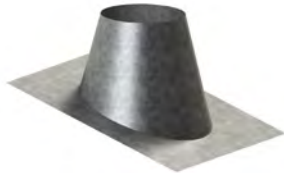
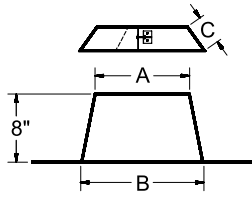

RFA, RFB

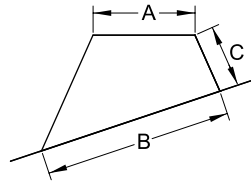

(RF, RFA & RFB) Used to provide weather protection where the chimney penetrates the roof. Three models are available to accommodate various roof pitches. The storm collar (RSC) is included.

(RMFA, RMFB, RMFC) These flashings are specifically designed for metal roofs and greatly simplify metal roof installations. They are made from galvalume steel only.

(RSF, RSFA, RSFB) Stainless steel flashings are available in 10" and 12" diameters. Dimensions are the same as standard flashings.

(RF) Roof Flashings (comes with RSC storm collar)						
Pitch	Flue I.D.	Code	Base W x L	A	B	C
Flat - 2/12	10"	10RF/10RSF	26 x 26	12 1/2	16 3/4	8
	12"	12RF/12RSF	28 x 28	14 1/2	18 3/4	8
	14"	14RF	30 x 30	16 1/2	20 3/4	8
	16"	16RF	32 x 32	18 1/2	22 3/4	8
	18"	18RF	34 x 34	20 1/2	24 3/4	8
	20"	20RF	36 x 36	22 1/2	26 3/4	8
	22"	22RF	38 x 38	24 1/2	28 3/4	8
	24"	24RF	40 x 40	26 1/2	30 3/4	8
1/12 - 7/12	10"	10RFA/10RSFA	31 x 31	12 1/2	20 3/4	11
	12"	12RFA/12RSFA	34 x 36	14 1/2	26 11/16	8 3/4
	14"	14RFA	36 x 36	16 1/2	25 3/16	11
	16"	16RFA	38 x 38	18 1/2	27 1/2	11
	18"	18RFA	41 x 41	20 1/2	29 3/4	11
	20"	20RFA	43 x 43	22 1/2	32 1/16	11
	22"	22RFA	45 x 45	24 1/2	34 5/16	11
	24"	24RFA	47 x 47	26 1/2	36 5/8	11
8/12 - 12/12	10"	10RFB/10RSFB	29 x 35	12 1/2	18 1/2	11
	12"	12RFB/12RSFB	34 x 40	14 1/2	31 1/2	8 5/16
	14"	14RFB	34 x 42	16 1/2	23 1/16	11
	16"	16RFB	36 x 44	18 1/2	25 3/8	11
	18"	18RFB	38 x 48	20 1/2	27 3/4	11
	20"	20RFB	41 x 50	22 1/2	29 15/16	11
	22"	22RFB	43 x 54	24 1/2	32 3/16	11
	24"	24RFB	45 x 56	26 1/2	34 1/2	11

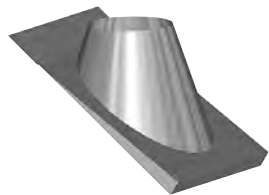

RMFA, RMFB, RMFC
Metal Roof Flashing
US Patent #7114301
Can Patent #2460044

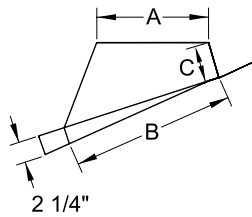

(RMF) Metal Roof Flashing Dimensions (comes with RSC storm collar)						
Pitch	Flue I.D.	Code	Base W x L	A	B	C
3/12 - 7/12	10"	10RMFA	25 1/2" x 25 3/4"	12 1/4	17 13/16	4
	12"	12RMFA	34 x 35 1/2"	14 1/4	26 13/16	4
8/12 - 12/12	10"	10RMFB	29 1/16" x 29 15/16"	12 1/4	22 31/32	4
	12"	12RMFB	34 1/4 x 38 7/8"	14 1/4	31 9/16	4
12/12 - 21/12	10"	10RMFC	27 1/2 x 42 3/4"	12 1/4	30 3/4	7 7/8
	12"	12RMFC	27 1/2 x 46 1/2"	14 1/4	38	7 3/4

* indicates the direction which 4 1/2" of metal flashing slides under the metal roof sheeting

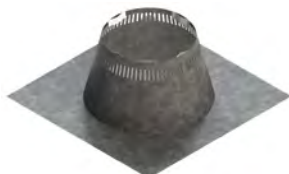

RVF

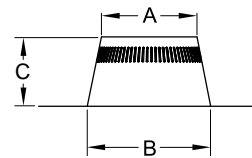

RVFA, RVFB

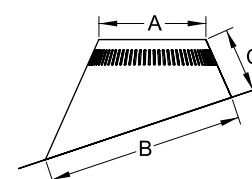

(RVF) Vented Flashing Dimensions (comes with RVSC storm collar)						
Pitch	Flue I.D.	Code	Base W x L	A	B	C
Flat - 2/12	10"	10RVF	28 x 28	13 1/4	18 1/4	10 1/2
	12"	12RVF	30 x 30	15 1/4	20 1/4	10 1/2
1/12 - 7/12	10"	10RVFA	32 x 34	13 1/4	23 3/16	8 7/8
	12"	12RVFA	34 x 36	15 1/4	27 7/8	9 1/16
8/12 - 12/12	10"	10RVFB	32 x 40	13 1/4	28 11/16	6
	12"	12RVFB	34 x 42	15 1/4	31 15/16	6

Vented flashings are required in certain applications where additional airflow is required.

Wall Support

(RWS, RWSG)

Designed to support a vertical chimney on a wall. There are two styles of wall support, one for 10" & 12" diameter RIS and one for all other diameters.



RWS for 10" & 12" diameters

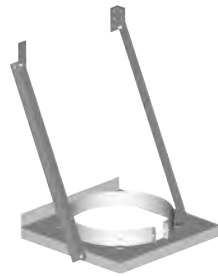

RWS & RWSG for all other diameters

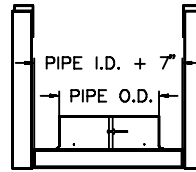

Wall Band

(RWB)

Used on vertical or horizontal runs of chimney to stabilize the chimney. The maximum distance between wall bands is 8'.

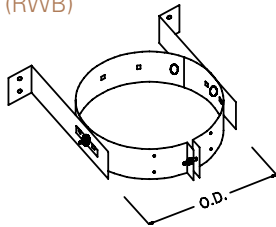

Offset Support

(ROS)

The offset support is primarily used to re-support the chimney above an offset. However it may also be used to provide additional support when the chimney height exceeds the capacity of the primary support.

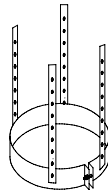

Roof Support

(RSR)

The roof support easily adjusts to any roof pitch. It can be used above an offset or to provide additional support and stability at the roof level.

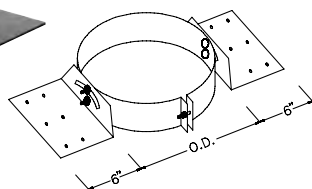

Roof Brace

(RRB)

Designed to provide a lateral support for the chimney above a roof. The roof brace must be fastened solidly into a structural member.

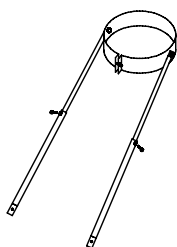

Locking Band
(RSLB & RGLB)



All RIS insulated components are designed to be fastened together with the stainless steel screws provided with each part. In some cases, it may be desirable to install a locking band for aesthetic purposes. The locking band is designed to overlap the two beads immediately above and below the chimney joint and fastens with a 1/4" bolt. All screws are required even when the locking band is installed. Available in stainless steel and galvalume.



Components for Renaissance Fireplaces

Roof Top Shield
(RTS)



The Roof Top Shield is required for Renaissance Fireplace installations. Designed to protect combustible roofs where the chimney passes through, it has adjustable mounting brackets that raise or lower the shield depending on the roof pitch. Radiation Shields do NOT reduce chimney clearance. Always maintain 2" clearance to chimney through radiation shields.

Dimensions		INCHES
ø	A	
10"	13 7/8	
12"	16 1/2	

Insulated Angled Wall Radiation Shields (RWRSI30 & RWRSI45)

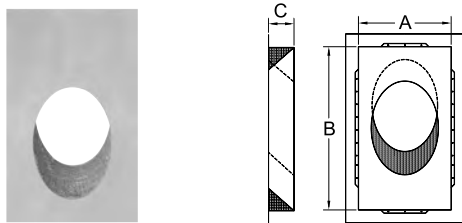

The insulated angled wall radiation shield is used when the chimney goes through a combustible exterior wall, with a 30° or 45° angle. A radiation shield is installed on the exterior side of the wall to complete the installation. This part is used for fireplace installations only. *Note: 45° are approved for use in Canada only.*

Required Opening Dimensions							INCHES
Angle	30°			45°			
	ø	A	B	A	B	C	
10°	15 5/8	46 3/8	15 5/8	31 1/2	4"		
12°	16 5/8	51 13/32	16 5/8	33 7/8	6"		

Rumford 1500
12" Radiation Shield
(12RRS2)

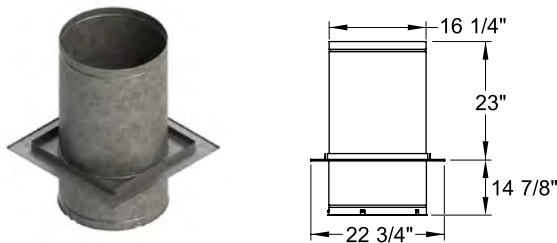

This radiation shield is required for installations of the Renaissance Rumford 1500B fireplace. No other radiation shield is certified with the Rumford 1500B. A radiation shield MUST be installed for each floor the chimney passes through. Radiation Shields do NOT reduce chimney clearance. Always maintain 2" clearance to chimney through radiation shields.

Components for Renaissance Fireplaces



Flexible Radiation Shield Tube

(12RRSF)

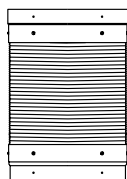

For Canada only. A flexible radiation shield tube (RM-12RRSF) must be installed around the chimney when it is enclosed in Rumford 1500 installations. This includes an outside chase. In the fireplace enclosure the flexible radiation shield tube is not required. Radiation Shields do NOT reduce chimney clearance. Always maintain 2" clearance to chimney through radiation shields.

Cathedral Ceiling Radiation Shields

(RRSC)

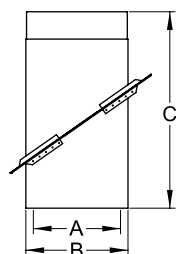

Designed to simplify installations through cathedral ceilings, our RIS Cathedral Ceiling Radiation Shields are fireplace certified specifically for Renaissance units. Radiation Shields do NOT reduce chimney clearance. Always maintain 2" clearance to chimney through radiation shields.

Code	Dimensions			
	A	B	C MIN.	B MAX.
10RM-RRSC	12 3/8	14 1/2	24	36
12RM-RRSC	14 3/8	16 1/2	24	36

INCHES

Attic Cathedral Ceiling Radiation Shield

(RM-12RRSCA)

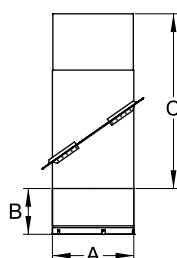

For Canada only - specific to the Rumford 1500. Similar to the Attic Radiation Shield for Cathedral Ceiling (ERSCA). Only, this component is designed for Renaissance Rumford 1500 installations where insulated chimney passes through a cathedral ceiling. The RRSCA has a flange at its base to connect a Radiation Shield Tube. Radiation Shields do NOT reduce chimney clearance. Always maintain 2" clearance to chimney through radiation shields.

Code	Dimensions			
	A	B	C MIN.	B MAX.
12RM-RRSCA	16 1/2	9 1/4	24	36

INCHES

Canadian vented flashing for Rumford 1500 Fireplace

(RCVF)

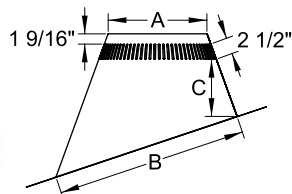
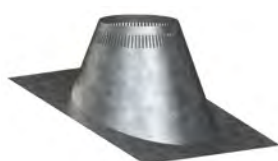

For Canada only. Includes a storm collar (RVSC).

Pitch	Flue I.D.	Code	Base W x L	Dimensions		
				A	B	C
Flat-2/12	12	RCVF	35 x 35	15 1/4	18	11 3/16
1/12-7/12	12	RCVFA	37 x 39	15 1/4	27 5/8	8 13/16
8/12-12/12	12	RCVFB	34 x 42	15 1/4	32 1/4	6

INCHES

Model RIS Offset Tables

RIS Offset Table 10 to 16 inches						
LENGTH BETWEEN ELBOWS	2 X 15°		2 X 30°		2 X 45°	
	RISE	OFFSET	RISE	OFFSET	RISE	OFFSET
10 INCH Ø						
NO LENGTH	11 7/8	1 5/8	14 1/8	3 3/4	15 7/8	6 5/8
12" Length	22 1/4	4 3/8	23 3/8	9 1/8	23 1/2	14 1/8
24" Length	33 7/8	7 1/2	33 3/4	15 1/8	32	22 5/8
48" Length	57	13 5/8	54 5/8	27 1/8	48 7/8	39 5/8
48" + 12"	67 3/8	16 1/2	63 7/8	32 1/2	56 1/2	47 1/4
48" + 24"	79	19 1/2	74 1/4	38 1/2	65	55 3/4
48"+24"+12"	89 3/8	22 3/8	83 5/8	43 7/8	72 5/8	63 3/8
48" + 48"	102 1/4	25 3/4	95	50 1/2	82	72 3/4
12 INCH Ø						
NO LENGTH	11 7/8	1 5/8	15	4	17 1/8	7 1/8
12" Length	22 1/4	4 3/8	24 3/8	9 3/8	24 3/4	14 3/4
24" Length	33 7/8	7 1/2	34 3/4	15 3/8	33 1/4	23 1/4
48" Length	57	13 5/8	55 1/2	27 3/8	50 1/4	40 1/8
48" + 12"	67 3/8	16 1/2	64 7/8	32 3/4	57 7/8	47 3/4
48" + 24"	79	19 1/2	75 1/4	38 3/4	66 1/4	56 1/4
48"+24"+12"	89 3/8	22 3/8	84 1/2	44 1/8	73 7/8	63 7/8
48" + 48"	102 1/4	25 3/4	96	50 3/4	83 1/4	73 1/4
14 INCH Ø						
NO LENGTH	12 7/8	1 3/4	16	4 1/4	18 7/8	7 3/4
12" Length	23 1/4	4 1/2	25 1/4	9 5/8	26 1/2	15 3/8
24" Length	34 7/8	7 5/8	35 5/8	15 5/8	35	23 7/8
48" Length	58	13 3/4	56 1/2	27 5/8	51 7/8	40 7/8
48" + 12"	68 3/8	16 5/8	65 3/4	33	59 1/2	48 1/2
48" + 24"	80	19 5/8	76 1/8	39	68	57
48"+24"+12"	90 3/8	22 1/2	85 1/2	44 3/8	75 5/8	64 1/2
48" + 48"	103 1/8	25 7/8	96 5/8	51	85	73 7/8
16 INCH Ø						
NO LENGTH	12 7/8	1 3/4	16 7/8	4 1/2	20 1/8	8 3/8
12" Length	23 1/4	4 1/2	26 1/4	9 7/8	27 3/4	16
24" Length	34 7/8	7 5/8	36 5/8	15 7/8	36 1/4	24 3/8
48" Length	58	13 3/4	57 3/8	27 7/8	53 1/4	41 3/8
48" + 12"	68 3/8	16 5/8	66 5/8	33 1/4	60 3/4	49
48" + 24"	80	19 5/8	77 1/8	39 1/4	69 1/4	57 1/2
48"+24"+12"	90 3/8	22 1/2	86 3/8	44 5/8	76 7/8	65 1/8
48" + 48"	103 1/8	25 7/8	97 7/8	51 1/4	86 1/4	74 1/2

All measurements are in inches

RIS Offset Table 18 to 24 inches						
LENGTH BETWEEN ELBOWS	2 X 15°		2 X 30°		2 X 45°	
	RISE	OFFSET	RISE	OFFSET	RISE	OFFSET
18 INCH Ø						
NO LENGTH	13 7/8	1 7/8	17 7/8	4 3/4	21 3/8	8 7/8
12" Length	24 1/4	4 5/8	27 1/8	10 1/8	29	16 1/2
24" Length	35 7/8	7 3/4	37 1/2	16 1/8	37 1/2	25
48" Length	59	13 7/8	58 1/4	28 1/8	54 1/8	41 7/8
48" + 12"	69 3/8	16 3/4	67 5/8	33 1/2	62 1/8	49 1/2
48" + 24"	81	19 3/4	78	39 1/2	70 5/8	58
48"+24"+12"	91 3/8	22 5/8	87 3/8	44 7/8	78 1/8	65 5/8
48" + 48"	104 1/8	26	98 3/4	51 1/2	87 1/2	75
20 INCH Ø						
NO LENGTH	13 7/8	1 7/8	19 1/4	5 1/8	23 1/8	9 5/8
12" Length	24 1/4	4 5/8	28 1/2	10 1/2	30 3/4	17 1/8
24" Length	35 7/8	7 3/4	38 7/8	16 1/2	39 1/8	25 5/8
48" Length	59	13 7/8	59 3/4	28 1/2	56 1/4	42 5/8
48" + 12"	69 3/8	16 3/4	69	33 7/8	63 3/4	50 1/4
48" + 24"	81	19 3/4	79 3/8	39 7/8	72 1/4	58 3/4
48"+24"+12"	91 3/8	22 5/8	88 3/4	45 1/4	79 7/8	66 3/8
48" + 48"	104 1/8	26	100 1/8	51 7/8	89 1/4	75 3/4
22 INCH Ø						
NO LENGTH	14 7/8	2	20 1/8	5 3/8	24	9 7/8
12" Length	25 1/4	4 3/4	29 1/2	10 3/4	31 5/8	17 1/2
24" Length	36 7/8	7 7/8	39 7/8	16 3/4	40 1/8	26
48" Length	60	14	60 5/8	28 3/4	57	43
48" + 12"	70 3/8	16 7/8	70	34 1/8	64 5/8	50 5/8
48" + 24"	82	20	80 3/8	40 1/8	73 1/8	59 1/8
48"+24"+12"	92 3/8	22 3/4	89 5/8	45 1/2	80 3/4	66 5/8
48" + 48"	105 1/8	26 1/8	101 1/8	52 1/8	90 1/8	76
24 INCH Ø						
NO LENGTH	14 7/8	2	21 1/8	5 5/8	25 3/4	10 5/8
12" Length	25 1/4	4 3/4	30 3/8	11	33 1/4	18 1/4
24" Length	36 7/8	7 7/8	40 3/4	17	41 3/4	26 3/4
48" Length	60	14	61 5/8	29	58 3/4	43 3/4
48" + 12"	70 3/8	16 7/8	70 7/8	34 3/8	66 3/8	51 1/4
48" + 24"	82	20	81 1/4	40 3/8	74 7/8	59 3/4
48"+24"+12"	92 3/8	22 3/4	90 5/8	45 3/4	82 1/2	67 3/8
48" + 48"	105 1/8	26 1/8	102	52 3/8	91 3/4	76 3/4

All measurements are in inches

SETTING THE STANDARD FOR THE PELLET CHIMNEY INDUSTRY

EXCELPellet has revolutionized the pellet chimney industry. It was the first pellet vent to include a silicone gasket seal on every part. It's not surprising EXCELPellet has spawned a league of impersonators. Today, nearly all pellet chimneys use a silicone gasket seal, but none have the innovative components or quality fit and finish of the original, EXCELPellet.

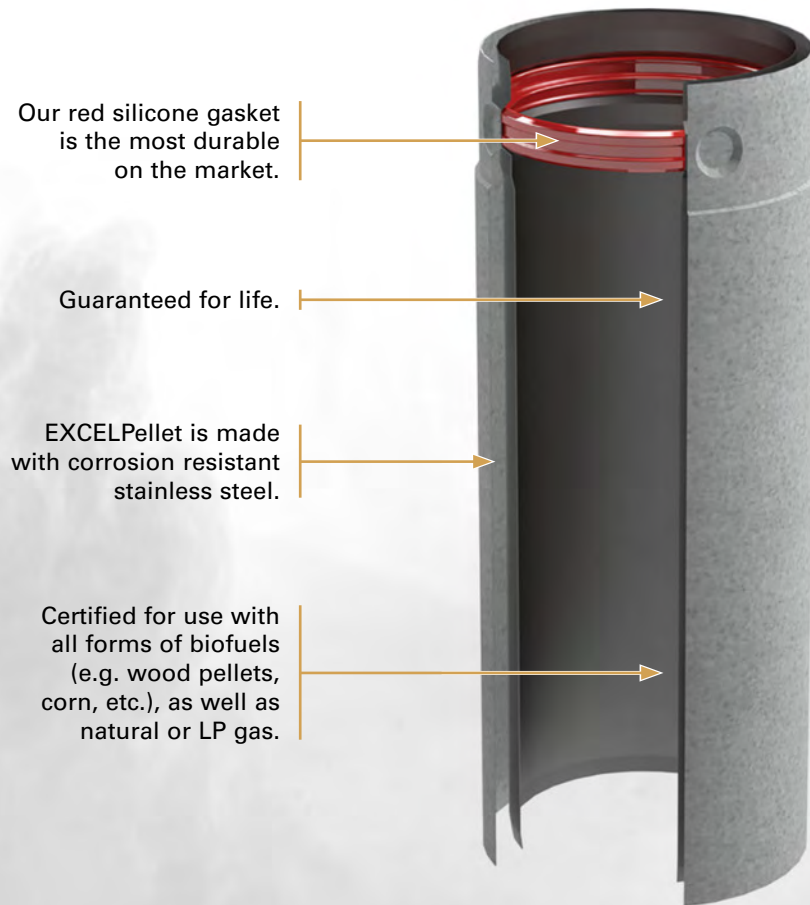

EXCELPellet

PELLET AND BIOFUEL VENTING SYSTEM



EXCELPellet Technical Information

Certification

EXCELPellet has been tested and listed to UL 641 and ULC S609 by Intertek Testing Services.

Applications

EXCELPellet is certified as a chimney liner for use on appliances that burn:

- Wood
- Agricultural products
- Natural or LP Gas

Allowable Flue Gas Temperatures

Max Continuous	300°C (572°F)
Tested To	927°C (1700 °F)

Clearance to Combustible Materials

EXCELPellet is certified for 1" clearance to combustible materials.

Construction

Flue: .016" laser welded stainless steel.

Casing: .019" laser welded Galvalume steel or .019" laser welded satin coat steel (painted)

Paint: Forrest "Stove Bright" flat black.

Insulation: 3/8" Air Space

Gasket: Silicone Rubber

EXCELPellet Engineering and Design Considerations

We suggest that your pellet system be designed with a vertical rise. This is not a requirement but will help the stove to vent combustion products in the case of a power failure.

Keeping the horizontal run and number of elbows to a minimum will reduce the cost of your installation and improve performance.

Although not required we recommend that terminations be installed 12" away from the wall to reduce the potential for smoke stain on outside walls. Refer to your stove manual for exact dimensions.

Do not install a vent smaller in diameter than the flue outlet on the stove.

EXCELPellet must be installed according to the installation instructions (available from your dealer upon purchase of support or on our web site).

EXCELPellet is manufactured using specialized machinery which makes it possible to maintain strict tolerances between components. This precision permits the use of a factory installed silicone gasket and eliminates the need for field application of silicone.

This unique factory installed silicone rubber gasket solves two major pellet venting problems:

- The gasket seals perfectly so there is no need for sealant application in the field. This speeds up installation, simplifies clean up, facilitates painting and eliminates callbacks.
- Not only do all parts assemble easily, they can be disassembled and reassembled just as easily making routine maintenance much easier.

EXCELPellet has a smooth attractive Black painted or Galvalume steel exterior. Galvalume is corrosion resistant and requires very little preparation for painting.



Intertek
4005717

EXCELPellet Typical Installations

NOTE: The following information is provided to assist you in selecting the chimney components required for your installation. It is intended to be a guideline only. These are not the installation instructions.

All measurements are in inches

Inside Diameter	3 Inch	4 Inch
Outside Diameter	3 3/4"	4 3/4"
Weight/Foot (lb/ft.)	1.3	1.6
Rough Opening Required:		
Supports (PSA, PSF)	5 3/4" x 5 3/4"	6 3/4" x 6 3/4"
Supports (PSS)	6 3/4" x 6 3/4"	6 3/4" x 6 3/4"
Wall Thimble (PWT)	6 1/2" x 6 1/2" or 6 1/2" round	7 1/2" x 7 1/2" or 7 1/2" round
Masonry Chimney Adapter (PAM)	6" to 8" dia.	6" to 8" dia.
Maximum Support capacity		
Ceiling Supports (PSA, PSF)	30 feet	25 feet
Ceiling Support (PSS)	37 feet	30 feet
Wall Support (PSW)	21 feet	17 feet

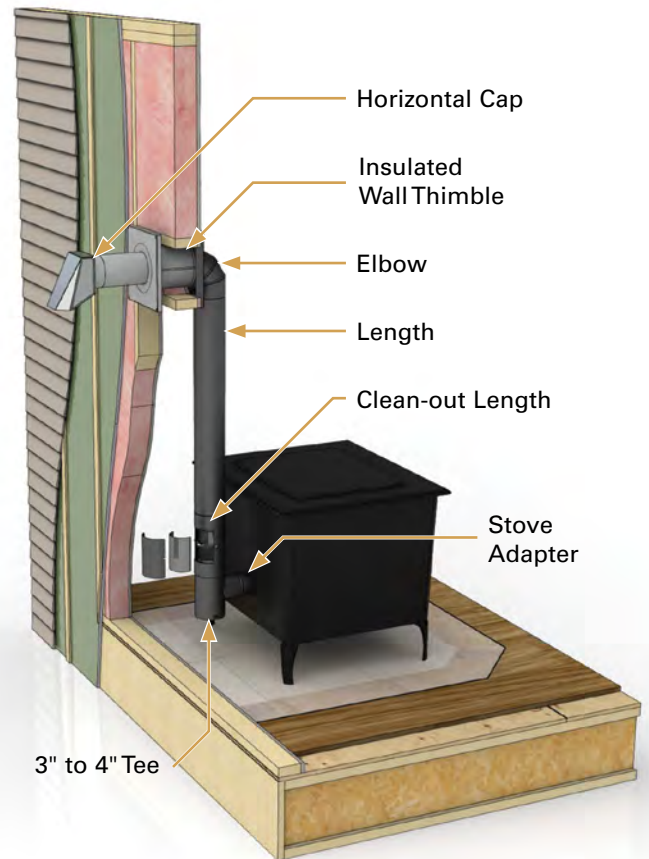
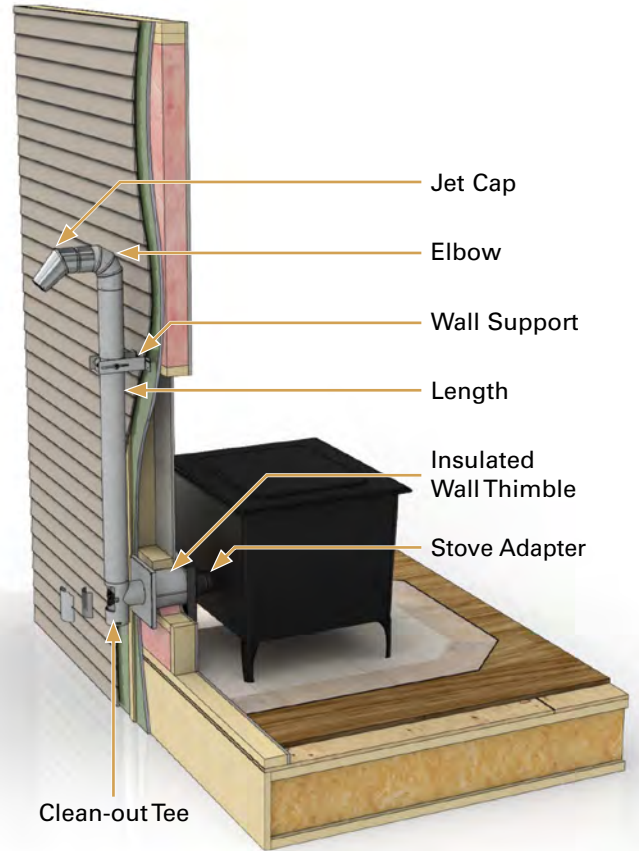
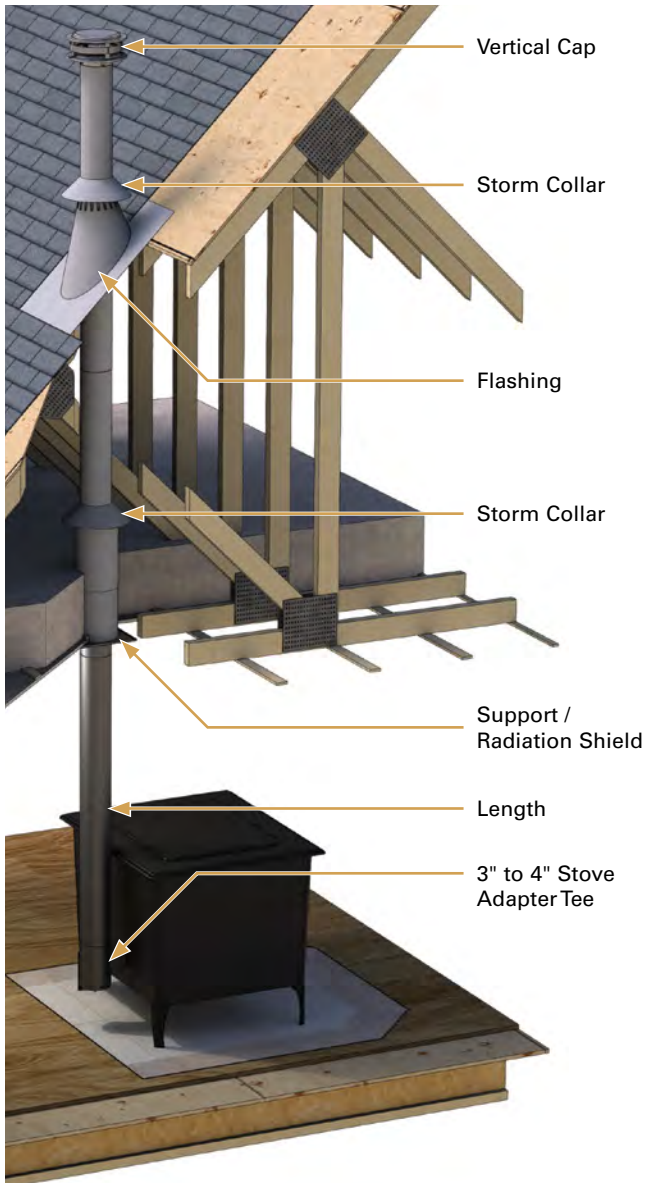

EXCELPellet Product Descriptions

Lengths

(PL5, PL5B, PLA6, PLA6B, PL16, PL16B, PLA16, PLA16B, PL1, PL1B, PL2, PL2B, PL3, PL3B, PL4, PL4B)

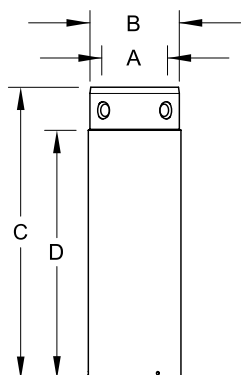

48", 36", 24", 16", 12", 5" & 6", 16" slip lengths, all lengths are available in Galvalume or Black exterior. Slip sections slide over standard length pellet vent.

INCHES

Length Dimensions						
	3"	4"				
A	3	4				
B	3 3/4	4 3/4				
Lengths	5"	12"	16"	24"	36"	48"
C	4 7/8	11 7/8	15 7/8	23 7/8	35 7/8	47 7/8
D	3 1/8	10 1/8	14 1/8	22 1/8	34 1/8	46 1/8
6" & 16" Slip Length Dimensions						
	3"		4"			
A	2 7/8		3 7/8			
B	3 7/8		4 7/8			
Lengths	6"		16"		16"	
C	7 3/4		15 3/4		15 3/4	
D	6		14		14	

Clean-Out Length

(PCOL)

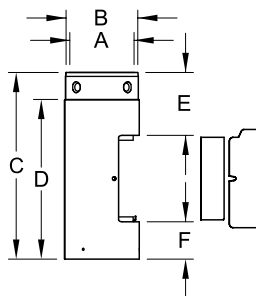

The removable casing allows access to the inside of the flue for easy cleaning. The Clean-Out length can be in any location as a substitute for a standard length.

INCHES

Clean-Out Length Dimensions		
	3"	4"
A	3 1/16	4 1/16
B	3 5/8	4 5/8
C	11 7/8	11 7/8
D	10 1/8	10 1/8
E	4 3/16	4 1/8
F	3 3/16	2 1/2

Tees

(PT, PTB, 3PT4, 3PT4B)

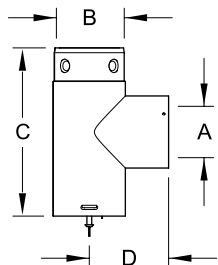

The tee cap incorporates a silicone gasket making it easy to remove for cleaning. All tees are available in Galvalume or Black exterior. Short snout places vent closer to stove. Tee cap included.

INCHES

Tee Dimensions			
	3"	4"	3" to 4"
A	3	4	3
B	3 3/4	4 3/4	4 3/4
C	8 3/4	9 3/4	8 3/4
D	4 1/8	4 5/8	4 5/8

Stove Adapter Tee

(3PAT3, 3PAT3B, 3PAT4, 3PAT4B)

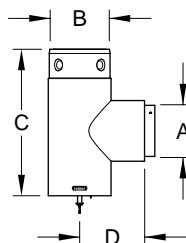

Stove Adapter Tees can be installed directly to the stove without the need for a stove adapter. Tee cap included.

INCHES

Stove Adapter Tee Dimensions		
	3"	3" to 4"
A	3	3
B	3 3/4	4 3/4
C	8 3/4	8 3/4
D	3 7/8	4 3/8
E	5/8	5/8

Clean-Out Tee (PCOT)

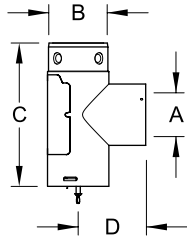

Allows easy access to the horizontal run of a system for cleaning. Tee cap included.

INCHES

Clean Out Tee Dimensions		
	3"	4"
A	3	4
B	3 3/4	4 3/4
C	8 3/4	9 3/4
D	4 1/8	4 5/8

Tee Cap (PTC, PTC1)



PTC



PTC1

If a replacement tee cap is required. Two versions of the tee cap exist depending on the style of your tee. The PTC is held in place with screws, the PTC1 is held with a bolt at the bottom of the cap.

Elbows

(PE45, PE45B, PE90, PE90B)

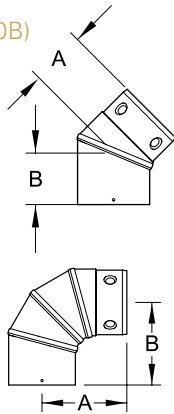

Small radius elbows make installations in tight spaces easier. 45° and 90° available, all elbows are available in Galvalume or Black exterior.

INCHES

Dimensions		
	A	B
3PE45	2 7/8	2 7/8
4PE45	3	3
3PE90	4 11/16	4 11/16
4PE90	5 1/4	5 1/4

Slip Elbow

(PE90S, PE90SB)

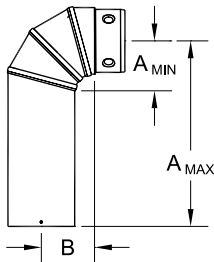

The vertical portion of the slip elbow slides over a standard pellet length just like a slip section. This eliminates the need for a separate slip piece.

INCHES

Dimensions			
Code	A max.	A min.	B
3PE90S	10 3/4	2 7/8	3
4PE90S	11 1/4	3 3/8	3 1/2

Clean-Out Elbow (PCOE)

(PCOE)

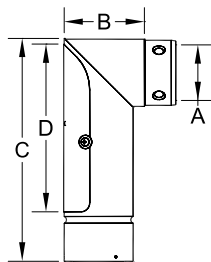

The removable casing allows access to the inside of the flue for easy cleaning. Typically used for "up and out" installations.

INCHES

Dimensions		
	3"	4"
A	3	4
B	4 1/2	5 1/2
C	12 3/8	13 3/8
D	9 3/8	9 7/8

3" - 4" Tapered Increaser (3PIT4, 3PIT4B)

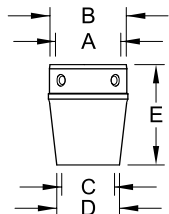

Used for increasing the diameter from 3" to 4" at any point in the system.

Dimensions		INCHES
A	4	
B	4 3/4	
C	3	
D	3 5/8	
E	6	

Insulated Wall Thimble (PWT)

(PWT)

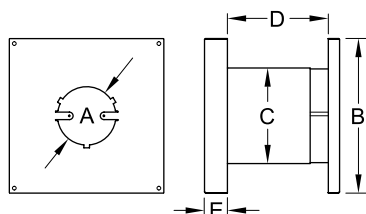

Telescopes to accommodate wall thicknesses from 5" to 10". It is fully insulated to maintain insulation integrity and fits tightly to prevent heat loss. The 3" requires a 6 1/2" X 6 1/2" framed opening; the 4" requires a 7 1/2" X 7 1/2" framed opening. A template for EXCELPellet wall thimbles can be purchased to simplify installation (PTMP).

Dimensions			INCHES
	3"	4"	
A	3 7/8	4 7/8	
B	9 1/4	10 1/4	
C	6 3/8	7 3/8	
D	min. 5 - max. 10		
E	1 1/2	1 1/2	

Wall Thimble with Integrated Outside Air (PWTOI)

(PWTOI)

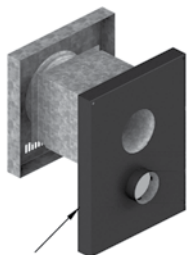

Insulated

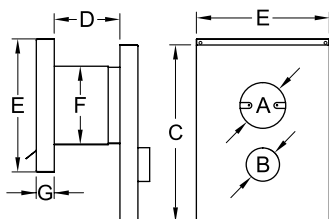

Simplifies a fresh air connection by integrating it into the same conduit as the wall thimble. This component is fully insulated through the wall and on the inside wall to prevent cold air or condensation in the home. Includes 10' of aluminum flex and 3' flex insulation.

Dimensions			INCHES
	3"	4"	
A	3 7/8	4 7/8	
B	2 7/8	2 7/8	
C	15	16	
D	min. 6 1/2 - max. 11 1/2		
E	11 1/4	12 1/4	
F	6 5/8	7 5/8	
G	1 1/2	1 1/2	

Wall Thimble with Outside Air Channel (PWTOC)

(PWTOC)

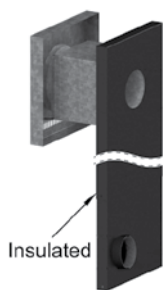

Insulated

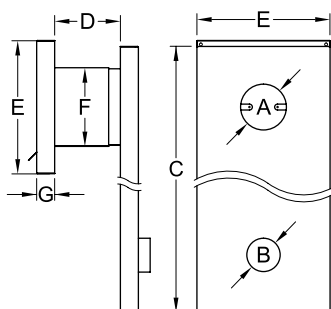

Functions similarly to the PWTOI, but designed for "up and out" installations (e.g. basement). The outside air channel is adjustable for height and can be painted any color to match the décor. Includes 10' of aluminum flex and 3' flex insulation.

Dimensions			INCHES
	3"	4"	
A	3 7/8	4 7/8	
B	2 7/8	2 7/8	
C	Adj. 44 - 68	Adj. 45 - 68	
D	min. 6 1/2 - max. 11 1/2		
E	11 1/4	12 1/4	
F	6 5/8	7 5/8	
G	1 1/2	1 1/2	

Wall Thimble Extension (PWTE)

(PWTE)

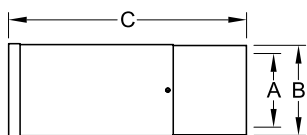

UL Listed Wall Thimble insulated extensions. They install easily and will allow wall thimbles to fit walls up to 20 3/4" thick.

Dimensions			INCHES
	3"	4"	
A	4 1/8	5 1/4	
B	6 1/4	7 1/4	
C	5 3/4 to 15		

Ceiling Support/Radiation Shield (PSA)

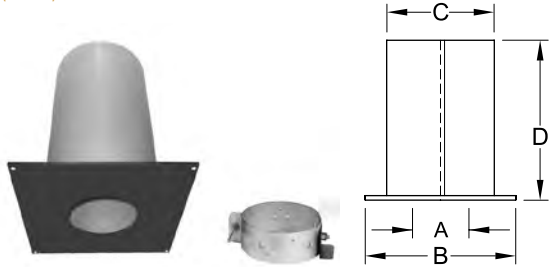

Rated to support up to 30' (3") or 25' (4") of venting where it passes through a floor or ceiling. It telescopes from 12" to 23" to keep insulation and debris away from the vent.

Dimensions		INCHES
	3"	4"
A	3 7/8	4 7/8
B	9 1/4	9 1/4
C	5 3/4	6 3/4
D	min. 12 - max. 23	

Square Support/Radiation Shield (PSS)

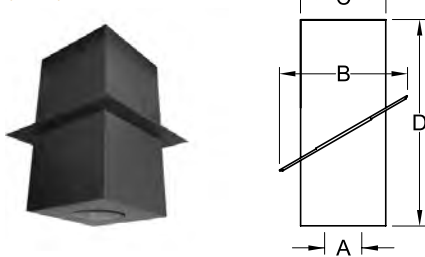

Rated to support up to 37' (3") or 30' (4") of venting where it passes through an insulated or un-insulated ceiling. It is particularly suitable for cathedral and drop ceilings.

Dimensions		INCHES
	3"	4"
A	3 7/8	4 7/8
B	10 3/4	10 3/4
C	6 5/8	6 5/8
D	16	16

Adjustable Wall Support (PSW)

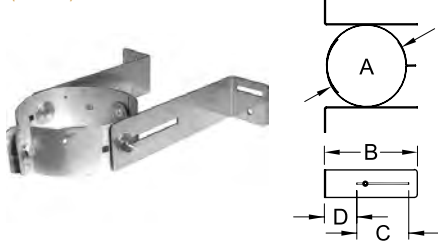

Rated to support up to 21' (3") or 17' (4") of venting. Fits 3" and 4" diameters. It adjusts easily to provide from 1" to 5" of clearance to the wall.

Dimensions		INCHES
	3"	4"
A	3 3/4	4 3/4
B	7 1/2	7 1/2
C	4 1/4	4 1/4
D	2 3/4	2 3/4

Masonry Adapter (PAM)

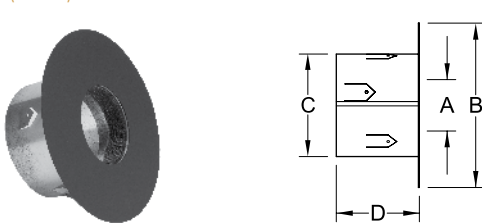

Provides a tight, positive transition to a masonry chimney. Fits existing masonry thimbles up to 8" in diameter.

Dimensions		INCHES
	3"	4"
A	3 15/16	4 15/16
B	9 1/2	9 1/2
C	5 7/8	5 7/8
D	3 3/4	3 3/4

Type A Chimney Adapter (PAA5, PAA6, PAA7, PAA8)

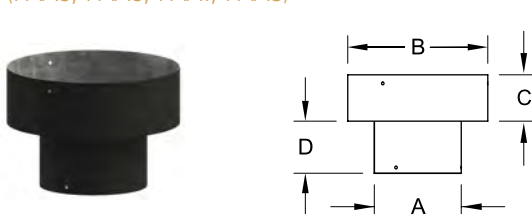

Provides a positive seal connection between EXCELPellet and class A chimneys. Connects 3" or 4" pellet vent to class A.

Dimensions		INCHES
	3"	4"
A	3 3/4	4 3/4
B	5, 6, 7 or 8	6, 7 or 8
C	2	2
D	2 1/4	2 1/4

Type A Chimney Reline Adapter

(PAX6, PAX7, PAX8)

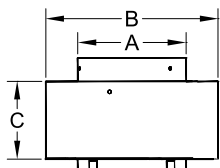

Permits re-lining of an existing pre-fab chimney with EXCELPellet or an approved flexible liner. Available to fit 6", 7" or 8" chimneys with 3" or 4" venting. Use the universal Chimney Adapter Cap (PCA) at the top.

		Dimensions	
		3"	4"
A		3 7/8	4 7/8
B		6, 7 or 8	
C		2 3/4	2 3/4

INCHES

Chimney Adapter Cap

(PCA)

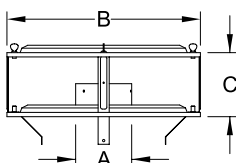

This cap will fit any brand of class A chimney up to an 8" I.D. It connects to EXCELPellet or a flexible liner used to re-line the existing chimney. Available in 3" or 4".

		Dimensions	
		3"	4"
A		3 3/4	4 3/4
B		13 1/2	
C		5	5

INCHES

Female Flex Adapter

(PAF, 3PAF4, PAF5, PAF55, PAF6)

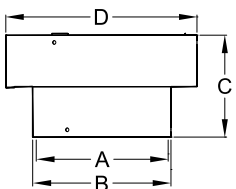

Connects ExcelPellet vent from an appliance to flexible liner coming from masonry flue.

Code	Dimensions			
	A	B	C	D
3PAF	3	3 3/4	5	3 5/8
3PAF4	3	3 3/4	2 3/4	4 5/8
3PAF5	3	3 3/4	3 1/2	5 1/2
3PAF55	3	3 3/4	3 1/2	6
3PAF6	3	3 3/4	3 1/2	6 1/2
4PAF	4	4 3/4	5	4 5/8
4PAF5	4	4 3/4	3 1/2	5 1/2
4PAF55	4	4 3/4	3 1/2	6
4PAF6	4	4 3/4	3 1/2	6 1/2

INCHES

Flex Adapter Tee

(3PATF4, 4PATF4)

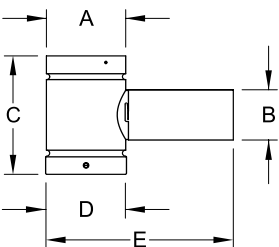

For pellet stove installations that are vented into a masonry chimney. The snout accepts EXCELPellet and connects EXCELPellet to a 4" flexible liner. The Flex Adapter tee has a removable twist mouth that is available in 3" or 4". Use in combination with the Masonry Adapter (PAM). Tee cap included.

		Dimensions	
		3"	4"
A		4 9/16	4 9/16
B		2 7/8	3 7/8
C		6 3/4	7 3/4
D		4 5/8	4 5/8
E		10 3/4	10 3/4

INCHES

Pellet / Liner 5" Adapter (PAL5)

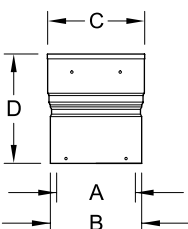

Provides a sealed connection where a rigid liner is installed above an EXCELPellet system.

		Dimensions	
		3"	4"
A		3	4
B		3 3/4	4 3/4
C		5	5
D		4 1/4	5 5/8

INCHES

Universal Stove Adapter

(PAS, PASB)

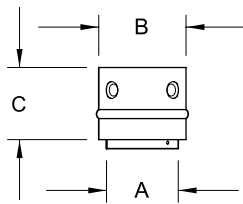

Universal adapter fits both large OD flue collars (e.g.: Harman) and small OD flue collars. The stove adapter fastens permanently to the stove but can be easily disconnected from the rest of the vent to simplify cleaning. Available in Galvalume or Black exterior.

Dimensions			INCHES
	3"	4"	
A	3	4	
B	3 5/8	4 5/8	
C	3 3/8		

Tapered Stove Adapter (3PI4, 3PI4B)

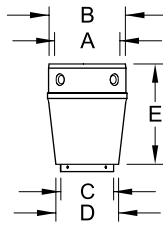

Universal Stove adapter that increases diameter from 3" to 4".

Dimensions		INCHES
A	4	
B	4 3/4	
C	3	
D	3 5/8	
E	6	

Quick Disconnect Stove Adapter (PAQ)

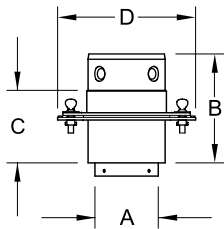

Makes cleaning and servicing pellet stoves dramatically easier. This stove adapter comes apart at the center by undoing two thumb screws. With the PAQ installed, there is no need to take lengths apart for cleaning.

Dimensions			INCHES
	3"	4"	
A	3	4	
B	5 3/8	5 3/8	
C	3 5/8	3 5/8	
D	4 3/4	5 3/4	

Harman Stove Adapter

(PASH, PASH6)

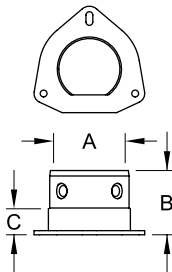

Bolts directly to Harman stoves and does not require silicone. Available in two lengths to accommodate stoves with extended hoppers. Includes a Harman Style Gasket (HG).

Dimensions			INCHES
	PASH	PASH6	
A	3	3	
B	2 7/8	6 3/8	
C	1 1/8	4 5/8	

Harman Style Gaskets (HG)

(HG)

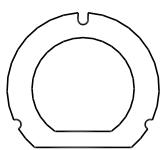

Replacement gaskets for the Harman Stove Adapter, comes in packs of 5.

Adjustable Jet Cap

(PCJ)

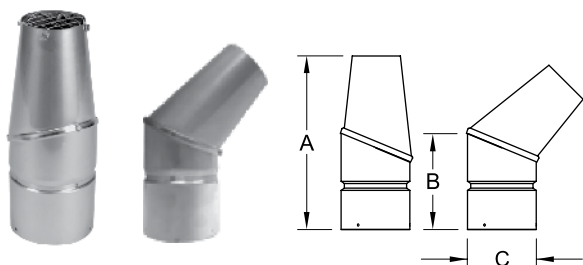

Can be rotated to direct hot flue gasses away from bushes or other things in proximity to the exhaust. Includes a spark screen.

INCHES		
Dimensions		
	3"	4"
A	9 3/8	9 3/4
B	5 1/2	5 7/8
C	3 3/4	4 3/4

Horizontal Cap

(PCH)

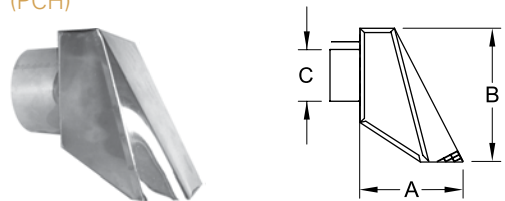

Directs and accelerates flue gasses away from the house reducing the possibility of "moustache effect" from smoke accumulation. Includes a spark screen.

INCHES		
Dimensions		
	3"	4"
A	5	6
B	6 1/4	8
C	3	4

Spark Screen

(PCS)

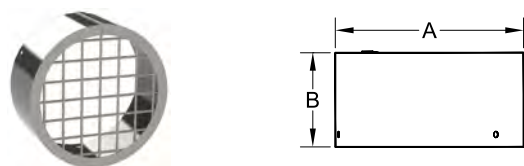

A stainless steel spark screen that fits any standard length or elbow to be used as a termination. Also fits Economy Cap (PCE).

INCHES		
Dimensions		
	3"	4"
A	3 3/4	4 3/4
B	1 7/8	1 7/8

Vertical Rain Cap (PCR)

Rain/Wind Shield (PRCW)



Vertical rain cap (PCR)

Vertical rain cap (PCR) with rain/wind shield (PRCW)

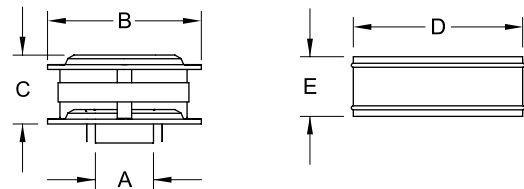

Constructed entirely of stainless steel and designed to provide good protection from wind and rain. An optional Wind/Rain Shield (PRCW) is available for added protection in harsh weather.

INCHES		
Dimensions		
	3"	4"
A	3	4
B	8	9
C	3 7/8	3 7/8
D	11	11
E	3 7/8	3 7/8

Vertical Cap Spark Screen

(PRCS)

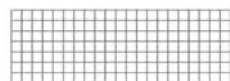

An optional stainless steel spark screen is available for installations where sparks can pose a safety problem

Traditional Masonry Adapter Cap (PCT)

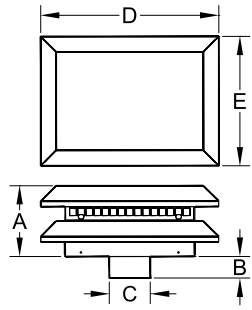

Certified for pellet appliances in a masonry chimney. Requires a flashing (CTF, or CTFC). The optional Wind / Rain Shield (CTS) can improve performance in extreme wind conditions. Cap can be reduced to 3 1/2" high to fit under slate or stone topped chimneys.

Dimensions		INCHES
A	6 1/2	
B	2 3/4	
C	3 3/4	
D	16 1/2	
E	12	

Universal Flashing for Traditional Cap (CTF)

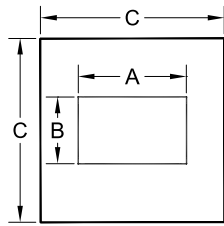

Made of galvalume, this flat flashing base is easy to cut, bend, or simply silicone to the top of a masonry chimney.

Dimensions		INCHES
A	11 3/4	
B	7 1/4	
C	20	

Clay Tile Flashing for Traditional Cap (CTFC)

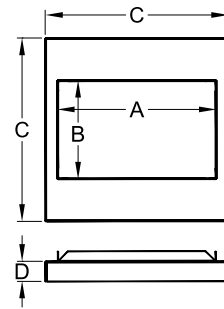

Made of galvalume and designed to fit onto a clay tile flue. Optional Hose Clamp Bracket (HC) can be used or it can be secured in the method of your choice.

Dimensions		INCHES
A	11 3/4	
B	7 1/4	
C	13 3/4	
D	1 1/2	

Hose Clamp Bracket (HC)

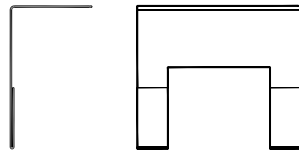

Heavy duty hose clamp and two mounting brackets for the Clay Tile Flashings (MFC and CTFC).

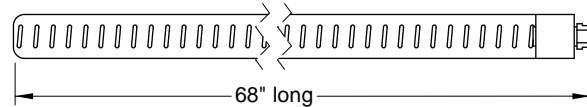

Flashings (PF, PFA, PFB)

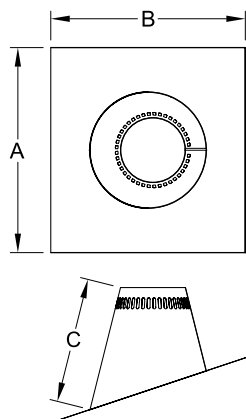

Flashing Dimensions						INCHES
Pitch	Code	Flue I.D.	A x B	C	Storm Collar	
Flat - 2/12	3PF	3	15 7/8 x 15 7/8	8 1/16	ØPSC	
	4PF	4	15 7/8 x 15 7/8	8 1/16	ØPSC	
1/12 - 7/12	3PFA	3	18 x 15 15/16	9 3/4	ØPSC	
	4PFA	4	18 x 15 15/16	10	ØPSC	
8/12-12/12	3PFB	3	22 1/2 x 18	14 1/4	ØPSC	
	4PFB	4	24 x 18	15 5/16	ØPSC	

A storm collar is included with purchase of a flashing

Storm Collars

(PSC)

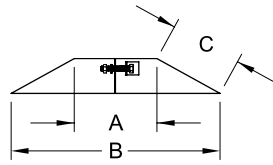

Dimensions		
	3"	4"
A	3 3/4	4 3/4
B	9 7/16	10 7/16
C	4	4

Metal Roof Flashing Adapter

(MFA, MFB)

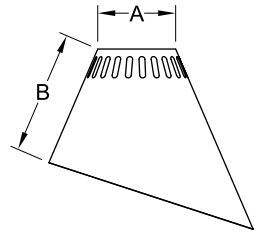

This flashing cone fits onto a 6" EXCEL Metal Roof Flashing (6EMFA or 6EMFB, page 16) to convert it for use with EXCELPellet vent or EXCELDirect. **Metal Roof Flashing and storm collar ordered separately.**

Dimensions				
Code	3MFA	3MFB	4MFA	4MFB
A	4	4	5	5
B	9 1/2	11 1/8	8	9 1/2

EXCELPellet Offset Tables

Use this table if you are not installing an adjustable length between the elbows

LENGTH BETWEEN OFFSETS	45° Elbows	
	RISE	OFFSET
3 INCH Ø		
NO LENGTH	7	2 3/4
6" Length	9 3/4	5 3/4
12" Length	14	10
24" Length	23 1/4	19 1/4
36" Length	31	27
48" Length	39 1/2	35 1/2
48" + 6" Length	42 1/2	38 1/2
48" + 12" Length	46 3/4	42 3/4
48" + 24" Length	55 3/4	51 3/4
48" + 36" Length	63 3/4	59 1/2
48" + 48" Length	72	68
48" + 48" + 12" Length	79 1/4	75 1/4
48" + 48" + 24" Length	88 1/2	84 1/2
4 INCH Ø		
NO LENGTH	7 1/4	3
6" Length	10	6
12" Length	14 1/4	10 1/4
24" Length	23 1/2	19 1/4
36" Length	31 1/4	27
48" Length	39 3/4	35 1/2
48" + 6" Length	42 3/4	38 1/2
48" + 12" Length	47	42 3/4
48" + 24" Length	56 1/4	52
48" + 36" Length	64	59 3/4
48" + 48" Length	72 1/2	68 1/4
48" + 48" + 12" Length	79 1/2	75 1/4
48" + 48" + 24" Length	88 3/4	84 1/2

All measurements are in inches

Use this table if you are installing a 16" adjustable length between the elbow

LENGTH BETWEEN OFFSETS	45° Elbows	
	RISE	OFFSET
3 INCH Ø		
6" Length*	13 1/2 - 21 1/2	9 1/2 - 17 1/2
12" Length	15 1/2 - 23 1/2	11 1/2 - 19 1/2
12" + 6" Length*	18 1/2 - 26 1/4	14 1/4 - 22 1/4
24" Length	24 3/4 - 32 1/2	20 1/2 - 28 1/2
36" Length	32 1/2 - 40 1/2	28 1/2 - 36 1/4
48" Length	41 - 48 3/4	37 - 44 3/4
48" + 6" Length	43 3/4 - 51 3/4	39 3/4 - 47 3/4
48" + 12" Length	48 - 56	44 - 52
48" + 24" Length	57 1/4 - 65 1/4	53 1/4 - 61 1/4
48" + 36" Length	65 - 73	61 - 69
48" + 48" Length	41 - 48 3/4	69 1/2 - 77 1/2
48" + 48" + 12" Length	80 3/4 - 88 3/4	76 3/4 - 84 1/2
48" + 48" + 24" Length	90 - 97 3/4	85 3/4 - 93 3/4
4 INCH Ø		
6" Length*	13 3/4 - 21 3/4	9 1/2 - 17 1/2
12" Length	15 3/4 - 23 3/4	11 1/2 - 19 1/2
12" + 6" Length*	18 3/4 - 26 3/4	14 1/2 - 22 1/2
24" Length	25 - 33	20 3/4 - 28 3/4
36" Length	32 3/4 - 40 3/4	28 1/2 - 36 1/2
48" Length	41 1/4 - 49 1/4	37 - 45
48" + 6" Length	44 1/4 - 52	40 - 48
48" + 12" Length	48 1/2 - 56 1/4	44 1/4 - 52
48" + 24" Length	57 1/2 - 65 1/2	53 1/4 - 61 1/4
48" + 36" Length	65 1/4 - 73 1/4	61 1/4 - 69
48" + 48" Length	73 3/4 - 81 3/4	69 1/2 - 77 1/2
48" + 48" + 12" Length	81 - 89	76 3/4 - 84 3/4
48" + 48" + 24" Length	90 1/4 - 98 1/4	86 - 94

All measurements are in inches

* Use a 6" adjustable length instead of the 16" adjustable length

EXCELDirect

DIRECT VENT FOR GAS & PROPANE APPLIANCES



EXCELDirect® Technical Information

Certification

EXCELDirect® is certified by INTERTEK testing services.

Applications*

EXCELDirect® is a certified venting system designed to be used only with certified direct vent gas fired appliances.

Clearance to Combustible Materials

As determined by the gas appliance specifications in its instruction manual.

Construction

Flue: .016" Stainless Steel

Casing: .019" Galvalume Steel or .022" Satin Coated (painted black)

Paint: Forrest "Stove Bright" flat black.

Seam: Interior and exterior seams are laser welded.

Sizes

4" interior X 6 5/8" exterior

5" interior X 8" exterior

* charts refer to inner diameter.

EXCELDirect® Design Considerations

Prior to starting your installation, we suggest you take the following into consideration:

- There are two possible ways to connect a direct vent venting system to a gas appliance:
 - The horizontal installation (through the wall);
 - The vertical installation (through the roof). Check the appliance manufacturer's installation instructions to see all possible vent configurations.
- Review all your options for the appliance location and also venting configuration. Try to minimize the alteration and reframing of structural components of the building (wall studs, water pipes, electrical wiring, ceiling joists, roof rafters, etc.). It may be easier to change the location of your appliance than to modify the building structure.
- Carefully read the appliance and the venting system instruction manuals. Good planning will save you time, work and money.
- Use only authorized EXCELDirect® listed components unless compatibility with another brand is specified in the appliance manufacturer's instructions. Do not use damaged parts.
- For a horizontal installation, you will have to take into consideration the distance between the gas appliance adapter to the wall, as well as the wall thickness and a vertical rise (if applicable). The horizontal vent termination on the exterior must be located in accordance with the Installation Codes and Regulations.
- For a vertical installation, you must consider the distance between the gas appliance outlet and the ceiling, the ceiling thickness, the height of the attic or second floor and allow sufficient vent height above roof line.
- For two-story applications, firestops are required at each floor. If an offset is needed in the attic, additional lengths and elbows will be required.
- Contact your local building authority and/or fire officials for permits, restrictions and installation inspections. You may also wish to contact your house insurance representative.

* For a list of manufacturer-specific appliance adapters, reference page 76.



EXCELDirect® Typical Installations

NOTE: The following information is provided to assist you in selecting the chimney components required for your installation. It is intended to be a guideline only. These are not the installation instructions.

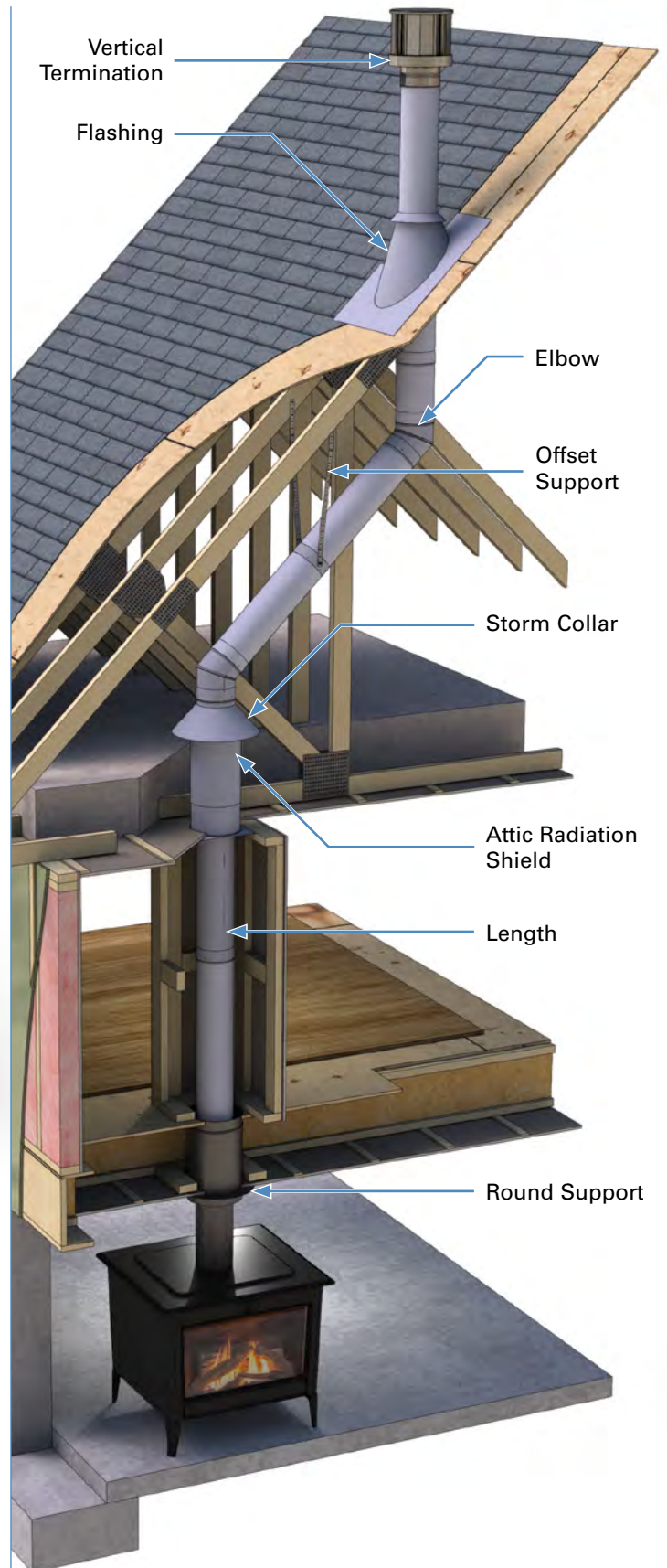
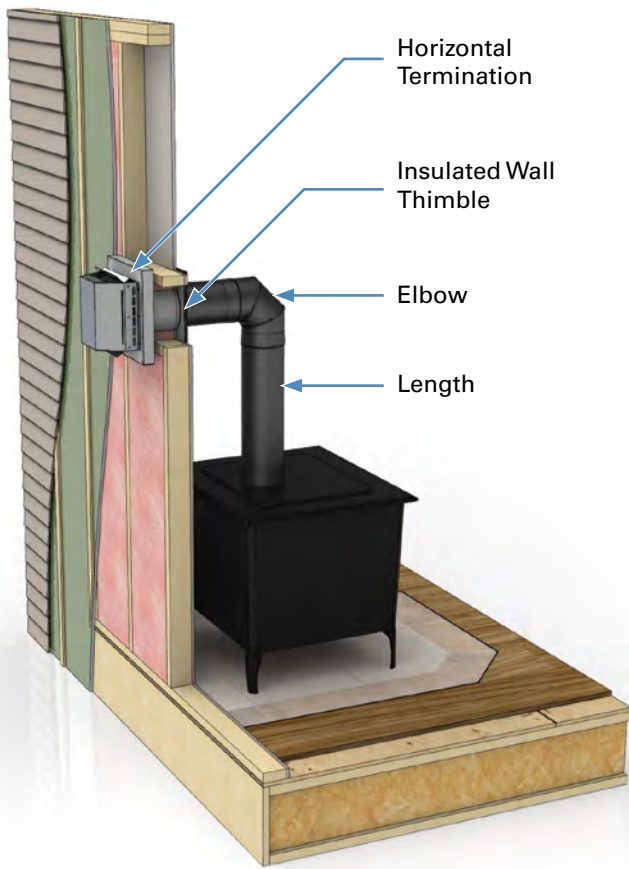

EXCELDirect® Product Descriptions

Horizontal Termination Kit

(4HTK)



This classic up and out kit includes a Horizontal Termination (HT), Insulated Wall Thimble (WT), Trim Plate (TP), Black 90° Elbow (DE90B), Black 9" Length (DL9B) and Black 2' Length (DL2B).

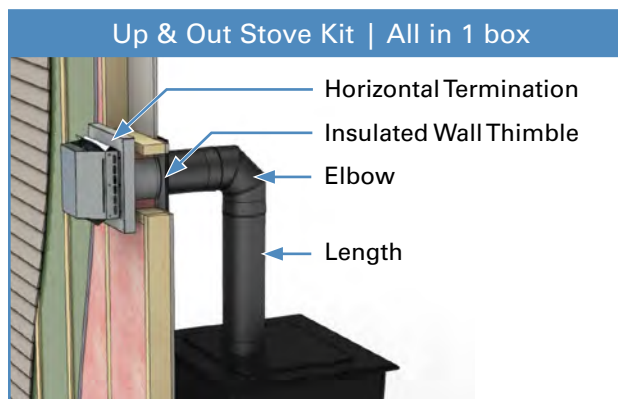

Lengths

(DL6, DL6B, DL9, DL9B, DL1, DL1B, DL2, DL2B, DL3, DL3B, DL4, DL4B)

EXCELDirect® lengths are available in 48", 36", 24", 12", 9" & 6". All lengths have a stainless steel interior and either a Galvalume or "Stove Bright" flat black exterior. **All EXCELDirect® lengths fit directly onto DuraVent® flue collars without the need for an adapter.**

Slip Lengths

(DLS1, DLS1B, DLS2, DLS2B)

Slip lengths enable an installer to adjust the system to the exact overall length required for any installation. Slip lengths must be installed above a straight length that is not adjustable and will not adjust into an elbow.

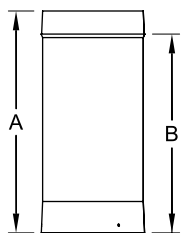

Dimensions		
Code	A	B
DL6	5 5/8	4 1/4
DL9	8 5/8	7 1/4
DL1	11 5/8	10 1/4
DL2	23 5/8	22 1/4
DL3	35 5/8	34 1/4
DL4	47 5/8	46 1/4

Slip Lengths	
DLS1	Adds 1 7/8" - 9"
DLS2	Adds 1 7/8" - 21"

INCHES

Telescopic Length

(DLA30, DLA30B)

The Telescopic Length includes two pipe sections that must be used together. The joint between the pipe sections is cleaner looking than using a slip length. Telescoping from 16 1/2" to 29" in length makes it ideal for up and out installations.

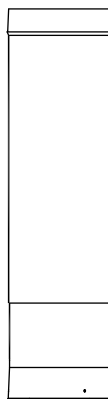

Telescopic Length	
DLA30	Adjustable from 16 1/2" to 29"

INCHES

Elbows 30°, 45° & 90°

(DE30, DE30B, DE45, DE45B, DE90, DE90B)

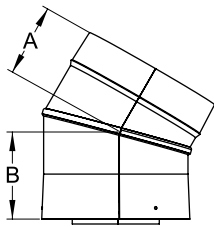
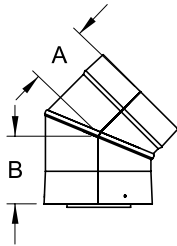
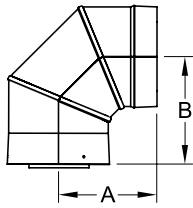

EXCELDirect® elbows are available in 45° and 90° and also in Black or Galvalume. The stainless steel inner casings are seam welded to ensure there is no leakage.

INCHES

Dimensions		
Code	A	B
4DE90	6 3/4	7
4DE45	3 5/8	4 3/8
4DE30	3 1/4	3 15/16
5DE90	7 5/8	7 7/8
5DE45	4	4 5/8
5DE30	3 1/4	3 15/16

Slip Elbow

(DE90S, DE90SB)

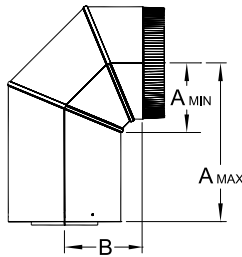

The vertical section of the slip elbow slides over a standard length just like a slip section of pipe. This eliminates the need for a separate slip piece. The installation can be completed faster and with fewer joints.

INCHES

Dimensions			
	A max.	A min.	B
4DE90S	11 1/2	4 3/4	6 7/8
5DE90S	11 1/2	5	7 3/4

Ceiling Support / Firestop

(CS)

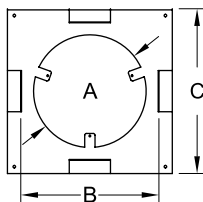
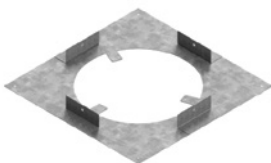

The Ceiling Support/Firestop is the most common support. It can be used on any floor level. It is the perfect choice when a structure hides the venting system. Simply screw the support to the framed joist with four #8 x 1 1/2" wood screws or use four spiral nails, 2" long. The Ceiling Support/Firestop acts as a firestop and a support when installed from below. It can also be installed above the joists; however an additional firestop is required from below in this case.

INCHES

Dimensions		
	4CS	5CS
A	6 3/4	8 1/8
B	8 3/4	10
C	10 3/4	12

Round and Square Support / Radiation Shield

(RDS, SS)

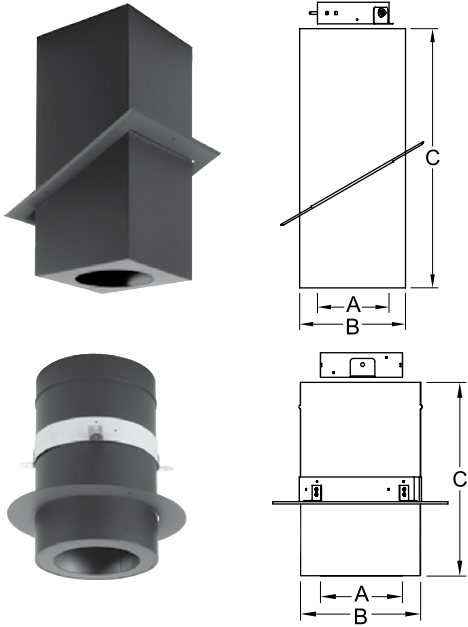

EXCELDirect® supports are suitable for use on flat or sloping ceilings. The amount they project into the room is determined only by the desired visual effect, but must be more than 1/4 inch. These supports are designed to act as a combination of support and attic radiation shield. To use either support as an attic radiation shield, simply close the open area at the top of the support (in the attic) with a storm collar. The Round & Square Supports can hold up to 50' of 4"x 6 5/8" venting or 40' of 5"x 8".

INCHES

Square Support Dimensions		
	4SS	5SS
A	6 3/4	8 1/8
B	9 3/4	10 3/4
C	24	24

Storm collar (ESQSC) ordered separately.

Round Support Dimensions		
	4RDS	5RDS
A	6 3/4	8 1/8
B	9 3/4	10 3/4
C	15 3/4	15 3/4

Storm collar (ESC) ordered separately.

Insulated Wall Thimble

(WT)

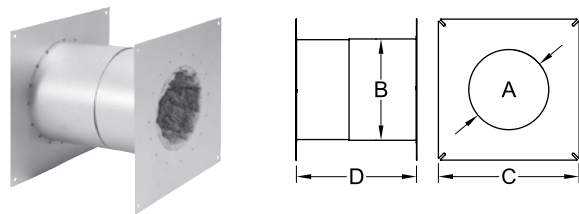

Telescopes to accommodate wall thickness from 4" to 10 1/2". It is fully insulated and fits tightly to prevent heat loss. The 4" X 6 5/8" venting requires an 8 3/4" x 8 3/4" framed opening; the 5" X 8" venting requires a 10" x 10" framed opening.

INCHES

Dimensions		
	4WT	5WT
A	7	8 3/8
B	8 5/8	9 7/8
C	12	13
D	4 to 10 1/2	4 to 10 1/2

Trim Ring, Trim Plate

(TR, TP)

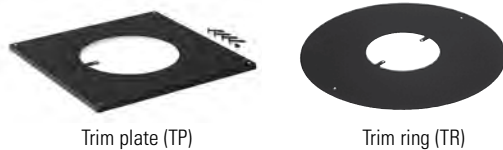

Trim plate (TP)

Trim ring (TR)

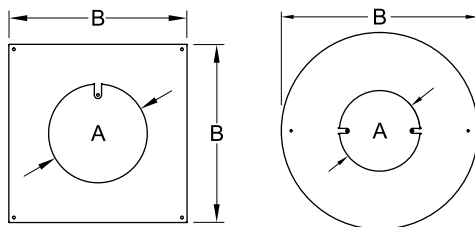

These are typically used as decorative covers when installing a wall thimble in a gas stove application. On vertical installations they can serve as firestops when installed from below. They can also serve as a firestop on horizontal installations that don't require a wall thimble (i.e. a fully non-combustible wall). The Trim Ring (TR) is larger and round and the Trim Plate (TP) is smaller and square. Available in black only.

All EXCELDirect trims include a rubberized O-ring to seal the gap between the trim and vent.

INCHES

Dimensions				
	4TP	4TR	5TP	5TR
A	6 7/8	6 7/8	8 1/4	8 1/4
B	12 1/4	19	13	20

Wall Thimble Extension

(WTE)

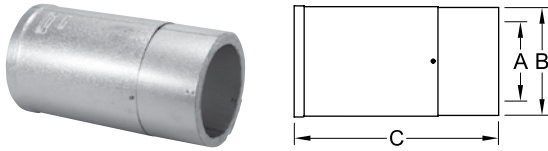

UL listed Wall Thimble insulated extensions. They install easily and will allow our standard wall thimble (WT) to fit walls up to 20 3/4" thick.

INCHES

Dimensions		
	4WTE	5WTE
A	6 7/8	8 1/4
B	8 1/2	9 3/4
C	5 3/4 to 15	

Attic Radiation Shield / Firestop

(AS)

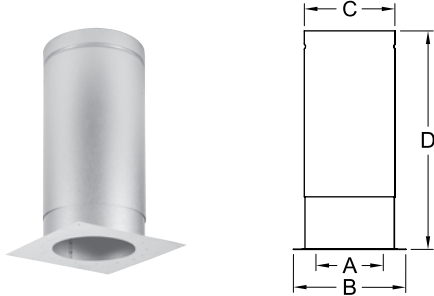

The Attic Radiation Shield / Firestop protects combustible framing in the floor or ceiling adjacent to the chimney, and also acts as a firestop spacer. When EXCELDirect® passes through the Attic Radiation Shield into an insulated space, a storm collar (SC) must also be installed to prevent the entry of insulation. This option CANNOT be used as a support and is typically used when the venting system will be enclosed.

INCHES

Dimensions		
	4AS	5AS
A	6 7/8	8 1/4
B	10 3/4	12
C	8 5/8	9 7/8
D	17 1/2 to 30	17 1/2 to 30

Reducer 5" – 4"

(R54)

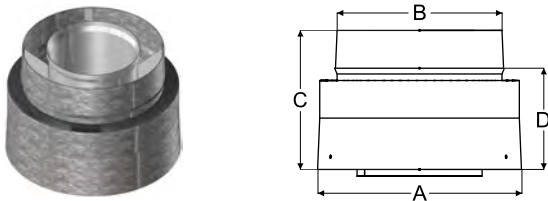

Only certain appliances are approved to use a reducer. Check the appliance manual. This component permits the transition from 5" x 8" to 4" x 6 5/8".

INCHES

Dimensions				
Code	A	B	C	D
R54	8"	6 5/8"	5 1/2"	4"

Adjustable Wall Support

(WS)

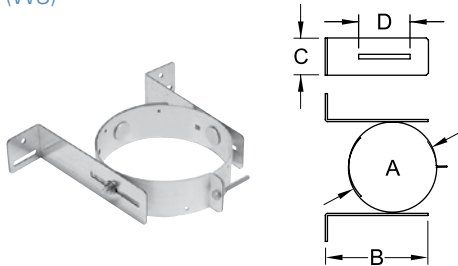

Rated to support up to 13' (4" x 6 5/8") or 10' (5" x 8") of venting. The universal support collar is adjustable for either the 6 5/8" or 8" outside vent casing. It adjusts easily to provide from 1" to 5" of clearance to the wall.

INCHES

Dimensions	
WS (universal)	
A	6 1/2 or 7 7/8
B	7 1/2
C	2
D	4 1/4

Offset Support

(OS)

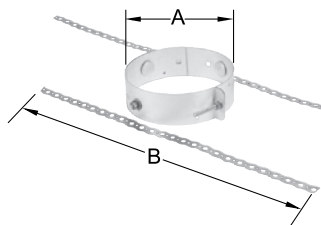

The offset support is primarily used to re-support the chimney above an offset. However it can also be used to provide additional support when the chimney height exceeds the capacity of the primary support, or to support horizontal runs. The offset support straps are 24 inches long and the collar is adjustable to fit the 6 5/8" or 8" outside vent casing.

INCHES

Dimensions	
OS (universal)	
A	6 1/2 or 7 7/8
B	24

Horizontal Terminations

(HT, RHT)



Horizontal Termination (HT)



Round Horizontal Termination (RHT)

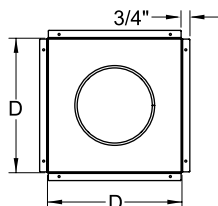
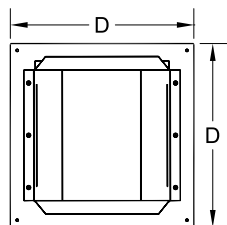
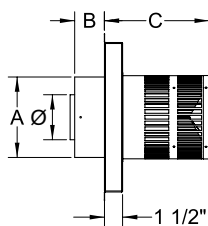
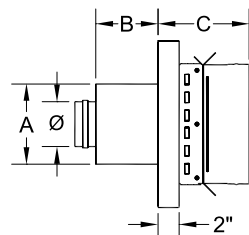

Our horizontal terminations are offered in two styles. Both are tested to high wind conditions and perform well even in winds equivalent to 40 mph. All Horizontal Terminations have built-in vinyl siding standoffs for siding up to 1 1/2" deep. For deeper siding, an additional Vinyl Siding Standoff (VSS) is required.

INCHES

Horizontal Termination Dimensions (HT)		
Ø	4"	5"
A	6 3/4	8 1/8
B	5 1/4	5 1/4
C	7 5/8	7 5/8
D	14	14

INCHES

Round Horizontal Termination Dimensions (RHT)		
Ø	4"	5"
A	6 3/4	8 1/8
B	2 1/2	2 1/2
C	8 7/8	8 7/8
D	12 1/2	12 1/2

Wind / Heat Shield for Horizontal Termination

(HTS)

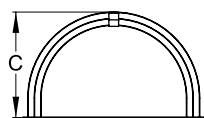
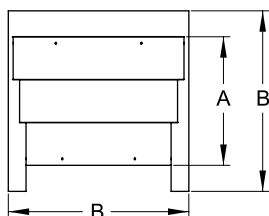

Provides additional wind and thermal protection. Required for specific appliance manufacturers; refer to your appliance manual for details about requirements. This shield also acts as a decorative shroud which can be painted.

INCHES

Dimensions (HTS)		
Ø	4"	5"
A	10	12
B	14	14
C	8 1/8	8 1/8

Wind / Heat Shield for Round Horizontal Termination

(RHTS)



Provides additional wind and thermal protection. Required for specific appliance manufacturers; refer to your appliance manual for details about requirements.

Vinyl Siding Standoff

(VSS)

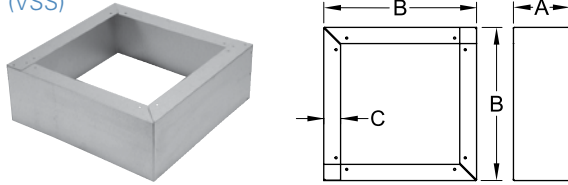

Required when siding is more than 1 1/2" deep. Prevents damage to temperature sensitive siding materials such as vinyl, shakes or shingles. For use with horizontal terminations only.

Dimensions		INCHES
Ø	VSS (universal)	
A	5	
B	14	
C	1 1/2	

Vertical Termination

(SVT)

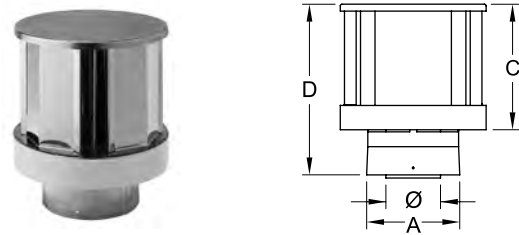

The SVT cap is made of stainless steel and is riveted during assembly to ensure lasting performance. It is certified to high wind applications where the vent terminates vertically. It cannot be installed horizontally.

Dimensions			INCHES
Ø	4"	5"	
A	6 5/8	8	
B	10 1/2	10 1/2	
C	9 1/2	9 1/2	
D	12 1/4	12 1/4	

Wind / Rain Shield

(4SVTS, CTS)

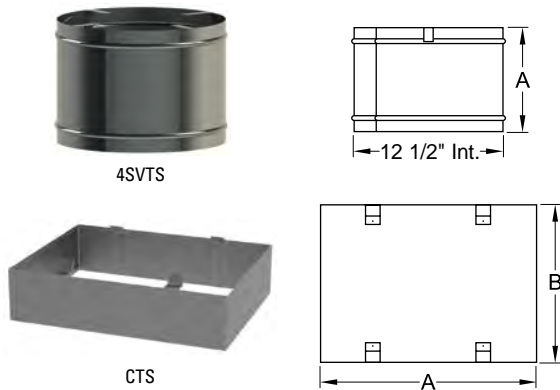

Optional Wind and Rain Shields prevent issues caused by strong wind or driving rain. The 4SVTS shield will fit the SVT or IVT cap, the CTS is for the Traditional Style caps.

Termination	Wind / Rain Shield
SVT, IVT	4SVTS
CT3, CT4, PCT	CTS

4SVTS Dimensions			INCHES
Code	A	B	
4SVTS	9 1/8	12 1/2	

CTS Dimensions				INCHES
Code	A	B	Height	
CTS	18 1/2	14	5	

Snorkel Termination

(ST14, ST36)

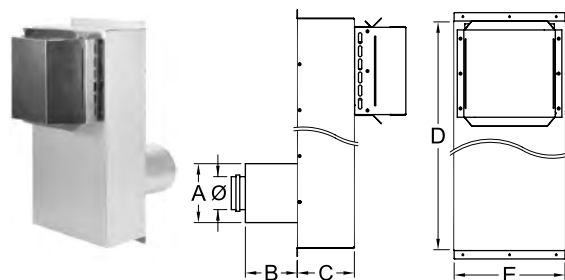

There are two Snorkel Terminations designed for use when a vertical rise is desired on the exterior of the home, or if the installation is below grade.

Dimensions					INCHES
Ø	ST14		ST36		
	4"	5"	4"	5"	
A	6 5/8	8	6 5/8	8	
B	7 to 10 3/4	7 to 10 3/4	7 to 10 3/4	7 to 10 3/4	
C	6 1/2	6 1/2	6 1/2	6 1/2	
D	26 3/8	26 3/8	48 3/8	48 3/8	
E	12 3/4	12	12 3/4	12	

Adjustable Flashing

(F, FA, FB)

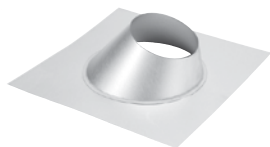

Flashings include a storm collar

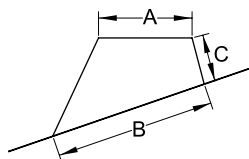

Our Flashings are made of galvalume steel and we have variations to fit any pitch.

For 5" x 8" EXCELDirect, a 6" EXCEL chimney flashing is used. Similarly, for installations through metal roofs, a 6" EXCEL Metal Roof Flashing should be used in combination with a Metal Roof Flashing Adapter (4MFA, 4MFB).

- 4F Flat roof
- 4FA 1/12 – 7/12 pitch roof
- 4FB 8/12 – 12/12 pitch roof

Flashing Dimensions							INCHES
Pitch	DV Size	Code	Base W x L	A	B	C	
Flat - 2/12	4 x 6 5/8	4F	20 x 20	7	12	8	
1/12 - 7/12	4 x 6 5/8	4FA	20 x 20	7	12 5/8	3 3/4	
8/12 - 12/12	4 x 6 5/8	4FB	22 x 26	7	17	3 3/4	
Flat - 2/12	5 x 8	6EF	See EXCEL Chimney Section				
1/12 - 7/12	5 x 8	6EFA					
8/12 - 12/12	5 x 8	6EFB					

Metal Roof Flashing Adapter

(MFA, MFB)

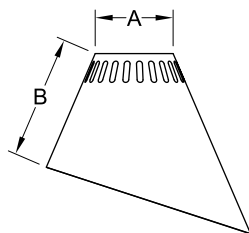

This flashing cone fits onto a 6" EXCEL Metal Roof Flashing (6EMFA or 6EMFB, page 16) to convert it for use with EXCELPellet vent or EXCELDirect. **Metal Roof Flashing and storm collar ordered separately.**

Dimensions			INCHES
Code	4MFA	4MFB	
A	5	5	
B	8	9 1/2	

Storm Collars

(SC, SQSC)



(SC)



(SQSC)

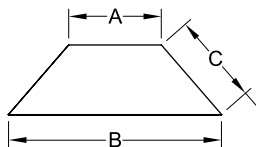
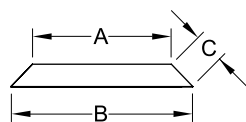

The storm collars fit both 4" x 6 5/8" and 5" x 8" EXCELDirect®. The regular Storm Collar (SC) is required to be used in combination with the Round Support or Attic Radiation Shield to form an attic insulation shield assembly when these components are installed into an insulated space. For square support installations, use the Square Support Attic Collar (SQSC) in an attic instead.

Dimensions			INCHES
	SC	SQSC	
A	6 1/2 or 7 7/8	6 1/2 or 7 7/8	
B	9 1/4 or 10 5/8	14 1/4 or 17	
C	2	6 7/16	

Restrictor Disk

(4RD)

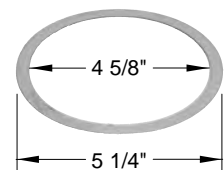

Used only in accordance with specific manufacturer's installation instructions to reduce the flow of combustion air.

Aluminum Flex Roll

(AL)



Our UL/ULC certified flex has gone through rigorous puncture and torsion testing to ensure continuous quality of every length. Rolls are available in 3" or 4" diameters.

- ØAL35: 35' roll
- ØAL50: 50' roll

Insert Vertical Termination

(IVT)

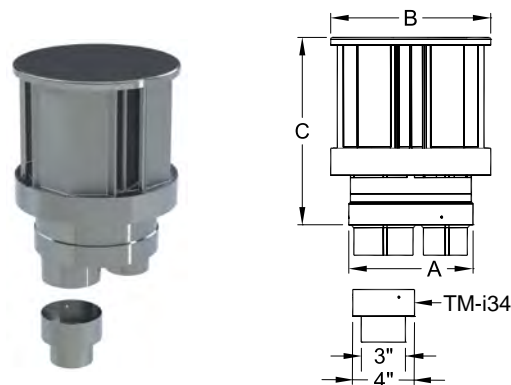

Used when installing a direct vent system in a masonry chimney using two aluminum flex liners. The IVT has a 3" air inlet and a 4" exhaust. An adapter for 3" exhaust is included. Requires a flashing (MF, MFR, MFC or IVTP). Certified for high wind. The optional Wind / Rain Shield (SVTS) can improve performance in extreme wind conditions. Stainless steel construction.

Dimensions	
A	8 1/8
B	10 1/2
C	12 1/4

INCHES

Universal Flashing for IVT

(MFR)

Made of galvalume, this flashing can be cut, bent, or secured with silicone to the top of a masonry chimney.

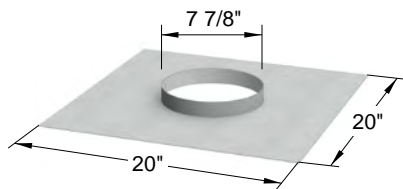

Clay Tile Flashing for IVT

(MFC)

Made of galvalume and designed to fit onto a clay tile flue. Optional Hose Clamp Bracket (HC) can be used or it can be secured in the method of your choice.

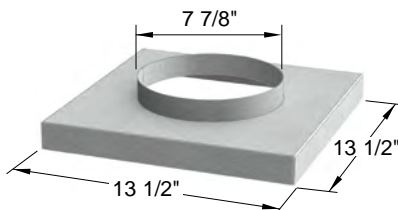

Masonry Flashing for IVT

(MF)

Made of stainless steel for added rigidity and corrosion resistance.

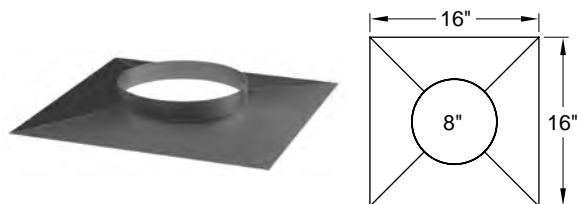

Prefab Chimney Top Adapter

(IVTP)

For co-linear direct vent installations in a prefab chimney. Will fit any round prefab chimney up to 11 1/2" OD. Use with the IVT termination only.

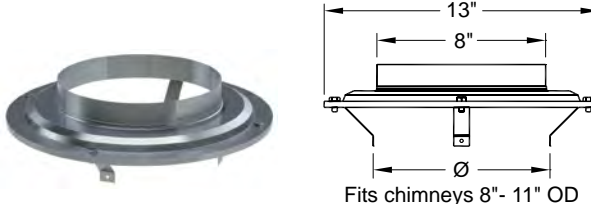

Fits chimneys 8"- 11" OD

Traditional Co-Linear Chimney Cap

(CT3, CT4)

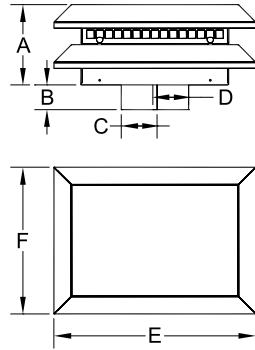

This stainless steel cap is designed for a direct vent insert installation in a masonry chimney that uses two flex liners. Requires a flashing (CTF, or CTFC). Certified for high wind. The optional Wind / Rain Shield (CTS) can improve performance in extreme wind conditions.

INCHES		
Dimensions		
	CT3	CT4
A	6 1/2	6 1/2
B	2	2
C	2 7/8	2 7/8
D	2 7/8	3 3/4
E	16 1/2	16 1/2
F	12	12

Universal Flashing for Traditional Cap

(CTF)

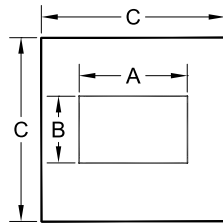
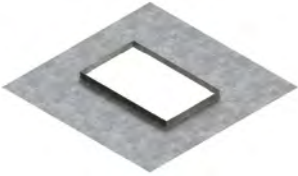

Made of galvalume, this flat flashing base is easy to cut, bend, or simply silicone to the top of a masonry chimney.

INCHES		
Dimensions		
A	11 3/4	
B	7 1/4	
C	20	

Clay Tile Flashing for Traditional Cap

(CTFC)

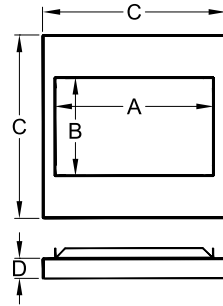

Made of galvalume and designed to fit onto a clay tile flue. Optional Hose Clamp Bracket (HC) can be used or it can be secured in the method of your choice.

INCHES		
Dimensions		
A	11 3/4	
B	7 1/4	
C	13 3/4	
D	1 1/2	

Hose Clamp Bracket

(HC)

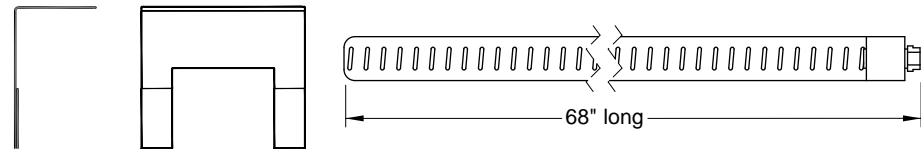

Heavy duty hose clamp and two mounting brackets for Clay Tile Flashings (MFC and CTFC).

Flex Liner Connector

(CFAA3, CFAA4)



Used to connect two pieces of flex together securely and without tearing. Available for 3" or 4" flex.

NEW**Coaxial Flex Adapter**

(4CFA, 5CFA)



Permits approved appliances to use coaxial aluminum flex rather than rigid EXCELDirect. The ØCFA includes an appliance adapter, a termination adapter, and clamps. Coaxial flex is not included.

Co-Axial to Co-Linear Appliance Adapter

(CAA)

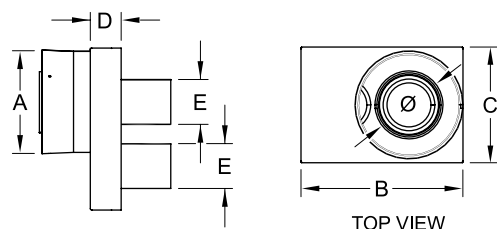

Use with direct vent gas appliances that require 4" x 6 5/8" venting. This part adapts a co-axial flue outlet to a flexible co-linear system to be used in an existing masonry chimney. **Flexible liners are ordered separately.**

INCHES

Dimensions	
Ø	4"
A	6 5/8
B	10 1/2
C	7 1/2
D	2
E	2 7/8

Co-Linear Termination Adapter

(CTA and CTA4)

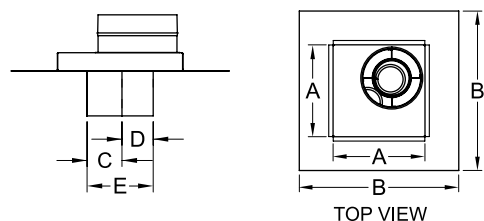

The Co-Linear Termination Adapter is for direct vent systems that are installed in existing masonry chimneys and use two co-linear liners. It is made out of stainless steel and is available with either 3" or 4" exhaust.

INCHES

Dimensions		
	CTA	CTA4
A	10 3/8	10 3/8
B	18	18
C	2 7/8	2 7/8
D	2 7/8	3 3/4
E	6 1/2	7 1/2

Co-Linear Masonry Adapter

(TM-4MAC33)

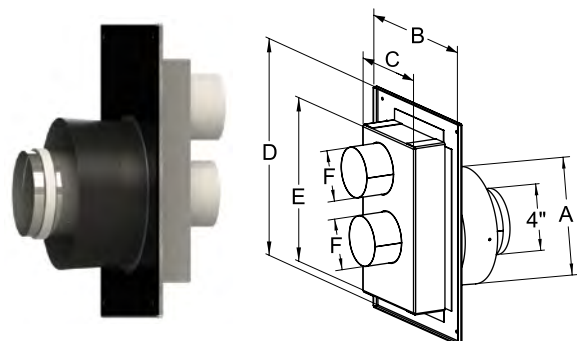

The Co-linear Masonry Adapter is designed for freestanding gas stove installations that will use a masonry chimney. Designed to fit 4x7 EXCELDirect, the built-in trim of the MAC is painted with Stove Bright Flat Black paint. Depending on the size of the existing thimble, some small masonry removal may be required, but the MAC has been built to the absolute minimum dimensions possible.

INCHES

Dimensions	
A	6 5/8
B	9 5/8
C	5 7/8
D	12 7/8
E	9 3/4
F	3

Type A Chimney Adapter

(CA6, CA7, CA8)

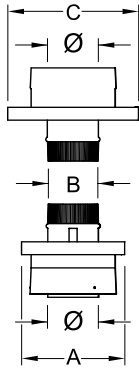

Provides a positive sealed connection between EXCELDirect® and class A chimneys. The Chimney Adapter includes a universal connector to tie into the existing chimney and an adapter to connect to an EXCELDirect® Vertical Cap (SVT). **4" flex and SVT termination sold separately.**

INCHES

Dimensions			
	4CA6	4CA7	4CA8
Ø	4"	4"	4"
A	6	7	8
B	4	4	4
C	8 1/8	9 1/8	10 1/8

USA only, not available in Canada

Masonry Adapter

(MA)

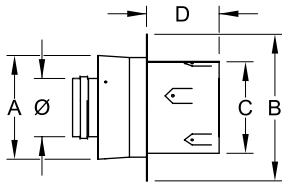

Easily connect a masonry chimney of any size to a freestanding gas stove with the Masonry Adapter. It is to be installed in combination with the MTA (Masonry Termination Adapter). **4" flex and SVT termination are sold separately.**

INCHES

Dimensions	
Ø	4"
A	6 5/8
B	9 1/2
C	5 7/8
D	3 3/4

USA only, not available in Canada

Masonry Termination Adapter

(MTA)

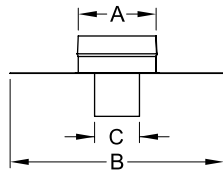

Adapts a 4" flexible liner to a direct vent system, typically used with the MA (Masonry Adapter). **4" flex and SVT termination sold separately.**

INCHES

Dimensions	
	MTA
A	6 5/8
B	18
C	4

USA only, not available in Canada

Traditional Masonry Adapter Cap

(PCT)

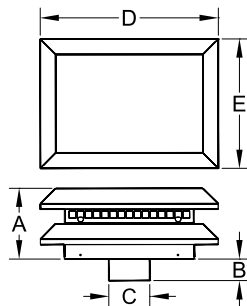

This stainless steel cap is designed for direct vent installations in a masonry chimney that uses a single 4" aluminum flex liner for exhaust and the masonry chimney for fresh air. Requires a flashing (CTF, or CTFC). Certified for high wind. The optional Wind / Rain Shield (CTS) can improve performance in extreme wind conditions.

INCHES

Dimensions	
A	6 1/2
B	2 3/4
C	3 3/4
D	16 1/2
E	12

EXCELDirect® Appliance Adapters

Manufacturer specific appliance adapters		
Adapter Code	Ø	Manufacturer
TM-4AA1	4" x 7"	VERMONT CASTINGS
TM-4AA2	4" x 7"	VALOR
TM-4AA3	4" x 7"	NAPOLEON
TM-4AA4	4" x 7"	KINGSMAN
TM-4AA5	4" x 7"	MHSC - Vermont Castings Group
TM-4AA6	4" x 7"	ARCHGARD
TM-4AA7	4" x 7"	REGENCY
TM-4AA8	4" x 7"	HEARTH & HOME TECHNOLOGIES
TM-5AA1	5" x 8"	KINGSMAN
TM-5AA2	5" x 8"	MHSC - Vermont Castings Group
TM-5AA3	5" x 8"	REGENCY
TM-5AA4	5" x 8"	KOZY HEAT
TM-5AA6	5" x 8"	MONTIGO
TM-5AA7	5" x 8"	ARCHGARD
TM-5AA8	5" x 8"	FABER

EXCELDirect fits directly onto DuraVent® flue collars without the need for an adapter.

See page 68.

EXCELDirect® Offset Tables

Vent Offset Specifications						
LENGTH BETWEEN OFFSETS	30° Elbows		45° Elbows		90° Elbows	
	RISE	OFFSET	RISE	OFFSET	RISE	OFFSET
4 INCH Ø						
NO LENGTH	10 3/4	2 7/8	10 1/2	4 3/8	10 3/4	10 3/4
6" Length	14 7/16	5	13 5/8	7 1/2	10 3/4	15 1/4
12" Length	19 5/8	8	17 7/8	11 3/4	10 3/4	21 1/4
24" Length	30	14	26 3/8	20 1/4	10 3/4	33 1/4
48" Length	50 13/16	26	43 3/8	37 1/4	10 3/4	57 1/4
5 INCH Ø						
NO LENGTH	10 3/4	2 7/8	11 3/4	4 7/8	12"	12"
6" Length	14 7/16	5	14 7/8	8	12"	16 1/2
12" Length	19 5/8	8	19 1/8	12 1/4	12"	22 1/2
24" Length	30	14	27 5/8	20 3/4	12"	34 1/2
48" Length	50 13/16	26	44 5/8	37 3/4	12"	58 1/2

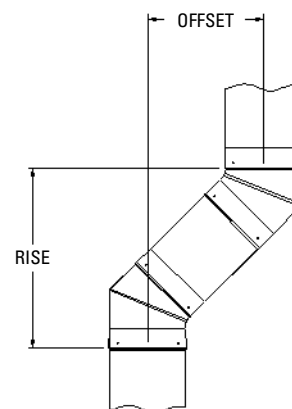

Open Fireplace Chimney Design Considerations

Chimney Sizing and Flue Height

The following information is provided to assist you in determining the correct chimney size and overall height required to provide trouble free operation. It is intended as a guideline only. There are many other factors, which determine the effective draft of a specific installation.

Sizing Fireplace Chimneys

The chimney-sizing chart on this page determines the correct chimney size for an open fireplace. For factory-built fireplaces and woodburning stoves, use the size specified by the appliance manufacturer. In most cases, this is the diameter of the flue collar.

If you need help with a more complicated shape such as a multisided fireplace or an open fire pit please feel free to contact us by phone, fax or e-mail. Our engineering department will be pleased to assist you with sizing, material specifications, and any other technical information you require.

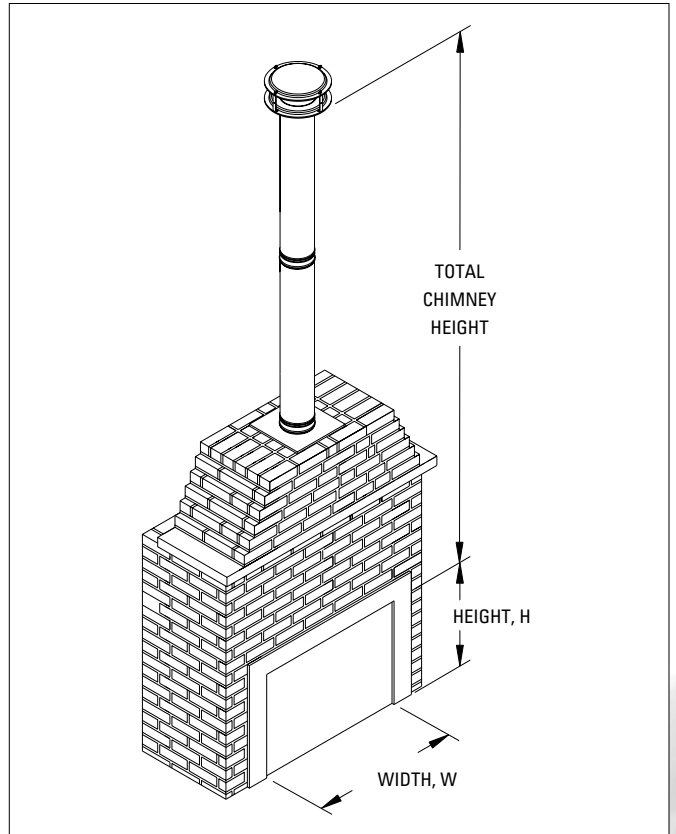

Example: A fireplace with a 24 inch wide by 18 inch high opening requires a 8 inch diameter chimney for 15' of chimney height.

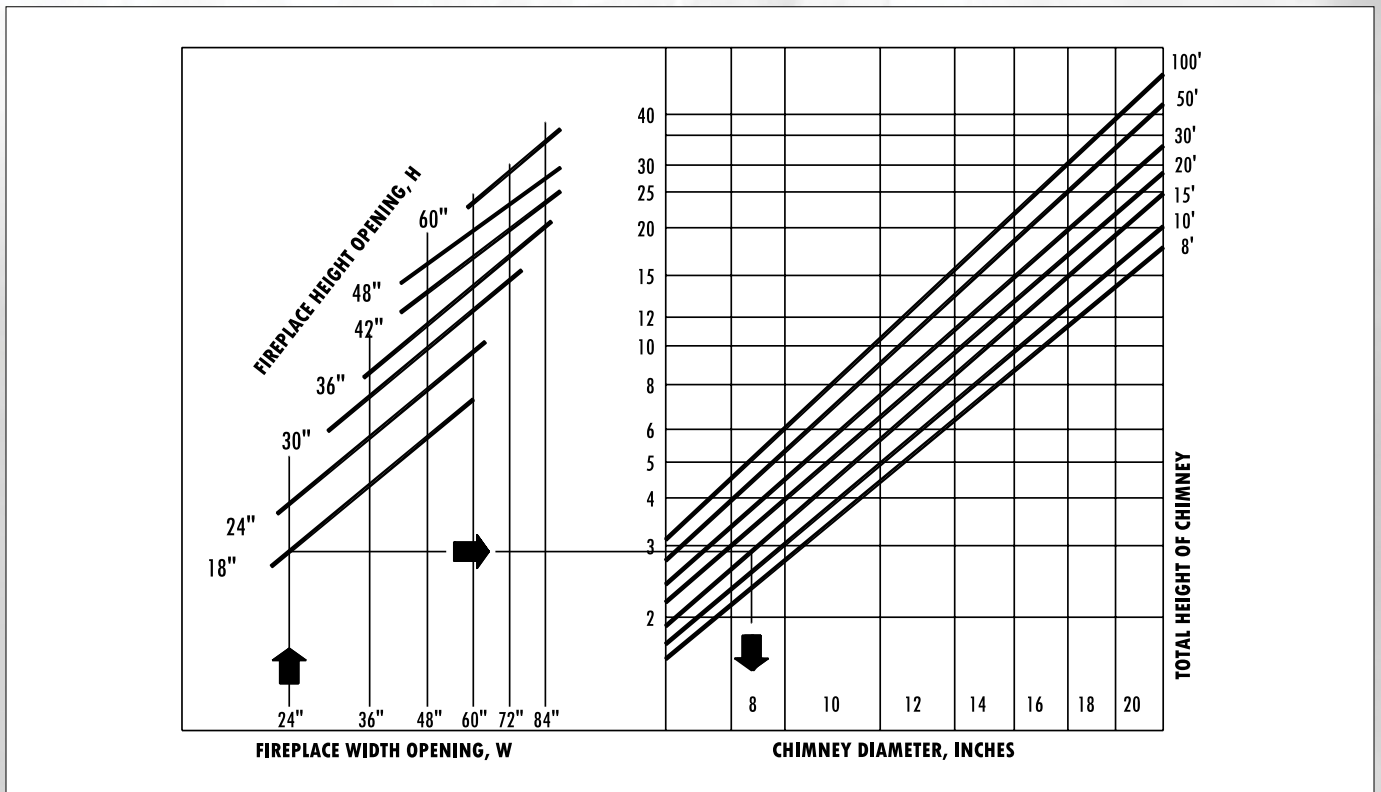

Chimney Height Design Considerations

Recommended Flue Height

Once the correct chimney size has been determined, there are two factors which can be compensated for when calculating the optimum height of the system-elevation and chimney layout. The higher the elevation, the greater the chimney height required to provide the same draft as an installation at sea level. The more complex the chimney layout is (the more tees, elbows, etc. in the system), the greater the chimney height required to provide the same draft as a straight up system.

The minimum overall height of any chimney system is 12 feet for a vertical chimney with no offsets at sea level.

You must increase the vertical height of the system to compensate for horizontal runs, tees, and elbows. To compensate for:

- One Tee** Add 3 feet. to the minimum height.
- One 45° Elbow** Add 1 feet. to the minimum height.
- One 90° Elbow** Add 2 feet. to the minimum height.
- Each foot of horizontal run** Add 2 feet. to the minimum height.
- Each 1000 feet. above sea level** Add 4% to the minimum height.

Example 1: House Built at Sea Level

A wood burning stove is installed on the main floor of a single story house at sea level. The chimney is installed with a 90° elbow through the wall into a tee, then straight up through the roof. To determine the minimum overall height add:

The minimum overall height =	12 feet
1 1/2 feet of horizontal run =	3 feet
One "Tee" =	3 feet
One 90° Elbow =	<u>2 feet</u>
Additional Height =	8 feet

The minimum overall chimney height required is 12 ft. + 8 ft. = 20 ft.

Example 2: Identical House Built at 8,000 feet

To determine the minimum overall height, add 32% (4% per 1000 feet) to the height calculated in the above example:

20 feet + 32% = 26.4 feet

If the house were built at an altitude of 5000 feet, the overall height would be:

20 feet + 20% (4% per 1000 feet.) = 24 feet

Minimum Recommended Flue Height from the flue connection on the appliance (feet)										
Elevation Above Sea Level (feet)	Number of elbows								1	2
	0	2 X 15°	2 X 30°	2 X 45°	4 X 15°	4 X 30°	4 X 45°			
0-1000	12	13	15	16	14	18	20	18	20	
1000-2000	12 1/2	13 1/2	15 1/2	16 1/2	14 1/2	19	20 1/2	19	21	
2000-3000	13	14	16	17	15	19 1/2	21 1/2	19 1/2	21 1/2	
3000-4000	13 1/2	14 1/2	17	18	15 1/2	20	22 1/2	20	22 1/2	
4000-5000	14	15	17 1/2	18 1/2	16	21	23	21	23	
5000-6000	14 1/2	15 1/2	18	19	17	21 1/2	24	21 1/2	24	
6000-7000	15	16	18 1/2	20	17 1/2	22 1/2	25	22 1/2	25	
7000-8000	15 1/2	16 1/2	19	20 1/2	18	23	25 1/2	23	25 1/2	
8000-9000	16	17	20	21	18 1/2	24	26 1/2	24	26 1/2	
9000-10000	16 1/2	17 1/2	20 1/2	22	19	24 1/2	27	24 1/2	27	

No more than two offsets (four elbows) allowed

1. This column shows the height required for a rear vented stove run 18" horizontally into a tee
2. This column shows the height required for a top vented stove with a 90° degree elbow and an 18" horizontal run into a tee

The table above can be used to determine the minimum height required for many common installations

Index

EXCEL | Insulated Stainless Steel Chimney

Adjustable Peak Flashing	17
Adjustable Stud Support	14
Anchor Plate	13
Anchor Plate Dampers	13
Attic Radiation Shield for Cathedral Ceiling	19
Attic Radiation Shields	19
Chimney Top Damper	10
Elbows	11
Extended Wall Supports	9
Flashings	15
Flexible Base Flashings	16
Flue Extension	14
Gable End Guide	14
Hardware Kit	14
Insulated Adjustable Lengths	10
Insulated Angled Wall Radiation Shields	13
Insulated Lengths	10
Insulated Tees	10
Locking Band	14
Metal Roof Flashings	16
Offset Support	11
Pitched Trim Rings	12
Radiation Shield	18
Radiation Shield for Cathedral Ceiling	18
Radiation Shield Tubes	19
Rain Caps	15
Roof Brace	14
Roof Brace Stiffener	14
Roof Radiation Shield	17
Roof Support	11
Round & Square Supports	12
Snow-Wedge	14
Stainless Trim for EWRS	13
Storm Collar	17
Support Extensions	12
Tee Cap	10
Universal Vinyl Siding Trim	14
Vented Flashings	17
Ventilated Chase Cone	17
Wall Channel	14
Wall Radiation Shields	13
Wall supports - Wall Bands	11

ULTRABlack | Double Wall Stove Pipe

Adjustable Lengths	23
Barometric Damper Adapter	24
Conical Trim Ring	25
Damper Section	25
Elbows	23
Increasesers	24
Lengths	23
Masonry Adapter	25

Masonry Thimble Adapter	25
Oval to Round Adapter	24
Reducers	24
Slip Lengths	23
Stove Adapters	24
Tees	23
Trim Collars	25

EXCELPrime | Single Wall Stove Pipe

12" Slip Flue Extension	33
Adjustable Elbow 90°	32
Adjustable Length	31
Barometric Damper Adapter	33
Clean Out Elbow 90°	32
Damper Section	31
Elbow	32
Heat Shield	34
Heat Shield Spacer	34
Increaser	33
Length	31
Masonry Adapter	34
Masonry Plug	34
Oval to Round Adapter	33
Reducer	33
Slip Elbow 90°	32
Slip Length	31
Tee	31
Tee Cap	31

EXCELiner | Rigid Chimney Liner

Adjustable Flex Adapter Elbow	40
Adjustable Snout Tees	39
Base Support	42
Elbows	40
Flex Liner Adapters	41
Increasesers and Reducers	41
Insulated Wall Thimbles	41
ITH Extension	41
Lengths	39
Offset Box	42
Rain Caps	42
Slip Lengths	39
Split Base Tees	39
Tee Cap	40
Top Supports	42
Twist Lock Tee	40

Model RIS Large Diameter Insulated Chimney	
Adjustable Lengths	45
Anchor Plate	46
Anchor Plate Damper	46
Attic Cathedral Ceiling Radiation Shield	50
Canadian vented flashing for Rumford 1500 Fireplace	50
Cathedral Ceiling Radiation Shields	50
Chimney Top Damper	46
Elbows	45
Flexible Radiation Shield Tube	50
Insulated Angled Wall Radiation Shields	49
Insulated Tees	45
Lengths	45
Locking Band	49
Offset Support	48
Radiation Shield	49
Rain Cap Base	46
Rain Caps	46
RIS 12" Radiation Shield	47
Roof Brace	48
Roof Flashings	47
Roof Support	48
Roof Top Shield	49
Spark Screen	46
Wall Band	48
Wall Support	48

EXCELPellet Venting for Pellet and Biofuels	
3" - 4" Tapered Increaser	58
Adjustable Jet Cap	62
Adjustable Wall Support	59
Ceiling Support/Radiation Shield	59
Chimney Adapter Cap	60
Clay Tile Flashing for Traditional Cap	63
Clean-Out Elbow	57
Clean-Out Length	56
Clean-Out Tee	57
Elbows	57
Female Flex Adapter	60
Flashings	63
Flex Adapter Tee	60
Harman Stove Adapter	61
Harman Style Gaskets	61
Horizontal Cap	62
Hose Clamp Bracket	63
Insulated Wall Thimble	58
Lengths	56
Masonry Adapter	59
Metal Roof Flashing Adapter	64
Pellet / Liner 5" Adapter	60
Quick Disconnect Stove Adapter	61
Rain/Wind Shield	62
Slip Elbow	57
Spark Screen	62
Square Support/Radiation Shield	59
Storm Collars	64
Stove Adapter Tee	56
Tapered Stove Adapter	61
Tee Cap	57
Tees	56

Traditional Masonry Adapter Cap	63
Type A Chimney Adapter	59
Type A Chimney Reline Adapter	60
Universal Flashing for Traditional Cap	63
Universal Stove Adapter	61
Vertical Cap Spark Screen	62
Vertical Rain Cap	62
Wall Thimble Extension	58
Wall Thimble with Integrated Outside Air	58
Wall Thimble with Outside Air Channel	58

EXCELDirect® Venting for Direct Vent Gas Appliances	
Adjustable Flashing	74
Adjustable Wall Support	71
Aluminum Flex Kits	75
Aluminum Flex Roll	76
Attic Radiation Shield / Firestop	71
Ceiling Support / Firestop	69
Clay Tile Flashing for IVT	76
Clay Tile Flashing for Traditional Cap	77
Coaxial Flex Adapter	78
Co-Axial to Co-Linear Appliance Adapter	78
Co-Linear Masonry Adapter	78
Co-Linear Termination Adapter	78
Elbows 30°, 45° & 90°	69
Flex Liner Connector	77
Horizontal 3 X 3 Co-Linear Flex Kit	75
Horizontal Termination Kit	68
Horizontal Terminations	72
Hose Clamp Bracket	77
Insert Vertical Termination	76
Insulated Wall Thimble	70
Lengths	68
Masonry Adapter	79
Masonry Chimney Conversion Kit	75
Masonry Flashing for IVT	76
Masonry Termination Adapter	79
Metal Roof Flashing Adapter	74
Offset Support	71
Prefab Chimney 3 x 3 Co-linear Flex Kit	75
Prefab Chimney Top Adapter	76
Reducer 5" - 4"	71
Restrictor Disk	74
Round and Square Support / Radiation Shield	70
Slip Elbow	69
Slip Lengths	68
Snorkel Termination	73
Storm Collars	74
Telescopic Length	68
Traditional Co-Linear Chimney Cap	77
Traditional Masonry Adapter Cap	79
Trim Ring, Trim Plate	70
Type A Chimney Adapter	79
Universal Flashing for IVT	76
Universal Flashing for Traditional Cap	77
Vertical Termination	73
Vinyl Siding Standoff	73
Wall Thimble Extension	71
Wind / Heat Shield for Horizontal Termination	72
Wind / Heat Shield for Round Horizontal Termination	72
Wind / Rain Shield	73



RSF Woodburning Fireplaces, a division of ICC, is one of North America's largest manufacturers of clean burning, high efficiency fireplaces. RSF has been designing leading edge woodburning products for over twenty years and manufactures the broadest range of environmentally friendly fireplaces on the market today.



CLEAN DOESN'T MEAN COMPROMISE

Renaissance Fireplaces is a line of high end award winning fireplaces which offer an unmatched view of the fire and very low emissions.

VIP | VIC | IS

ICC Chimney engineers a wide range of commercial/industrial chimney systems. We make insulated pressure stacks for applications ranging from forced draft boilers and industrial ovens to diesel engine exhaust systems. ICC can provide complete engineering and design services from preliminary chimney sizing and material specifications to detailed 3D AutoCAD assembly drawings.



INDUSTRIAL CHIMNEY COMPANY INC.
 Visit our website at www.icc-rsf.com
 400 J.F. Kennedy St. Jerome, Quebec, Canada, J7Y 4B7
 Tel.: (450) 565-6336 | Fax: (450) 565-6519