



Green Mountain 60

Model 8660



Illustrated Parts List

Full Assembly

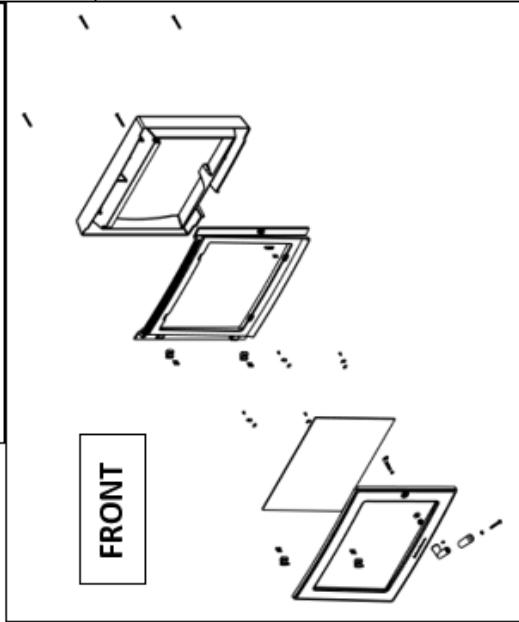
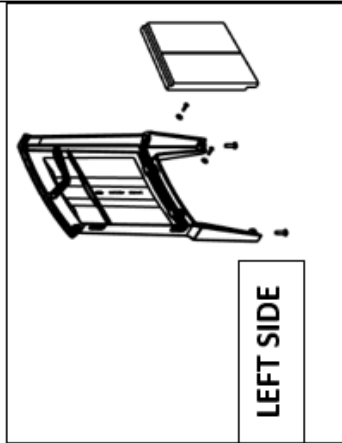
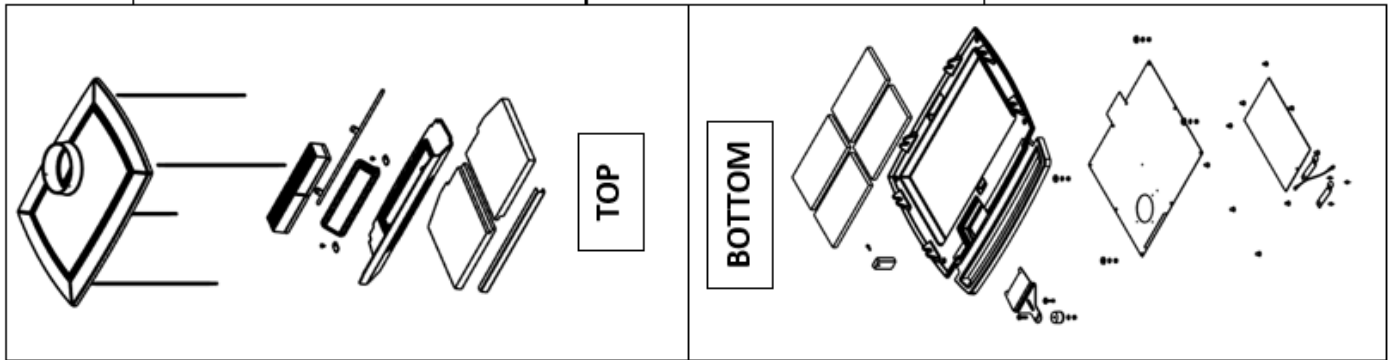
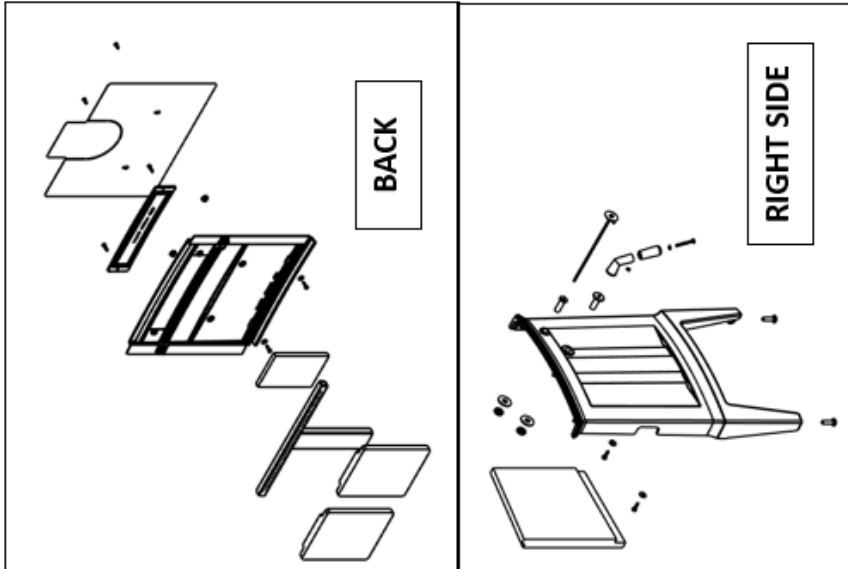

FRONT

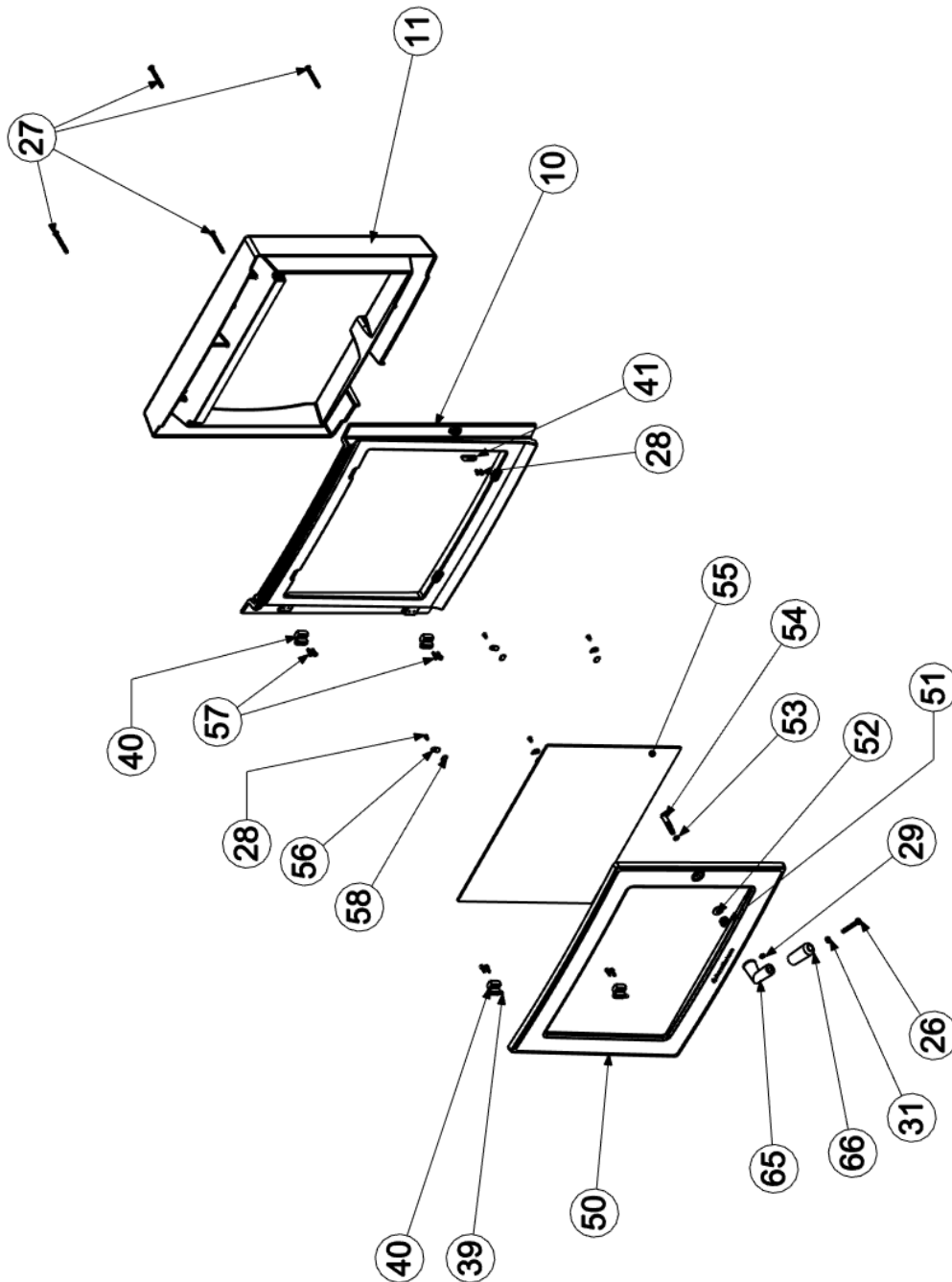

BOTTOM

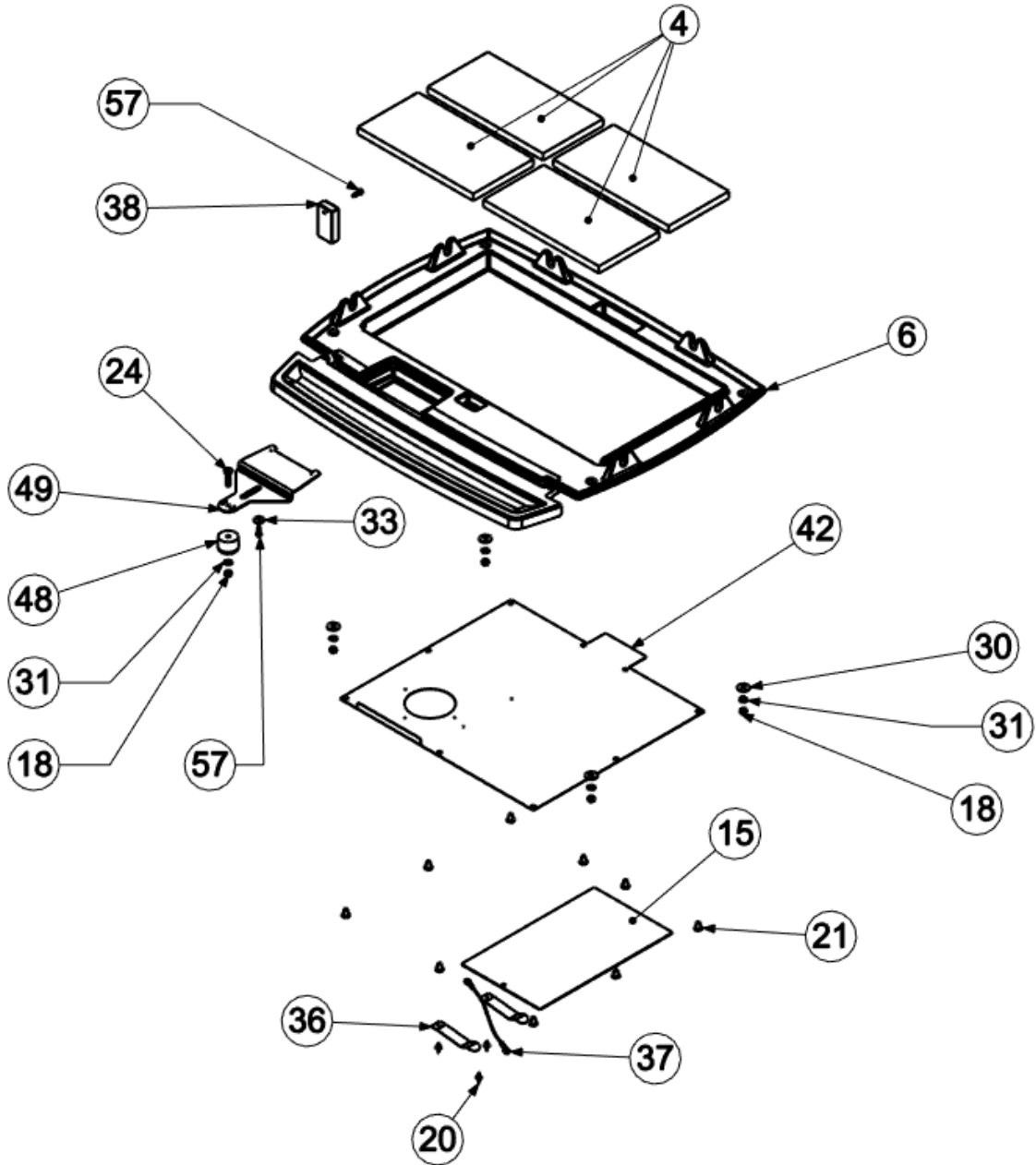

TOP

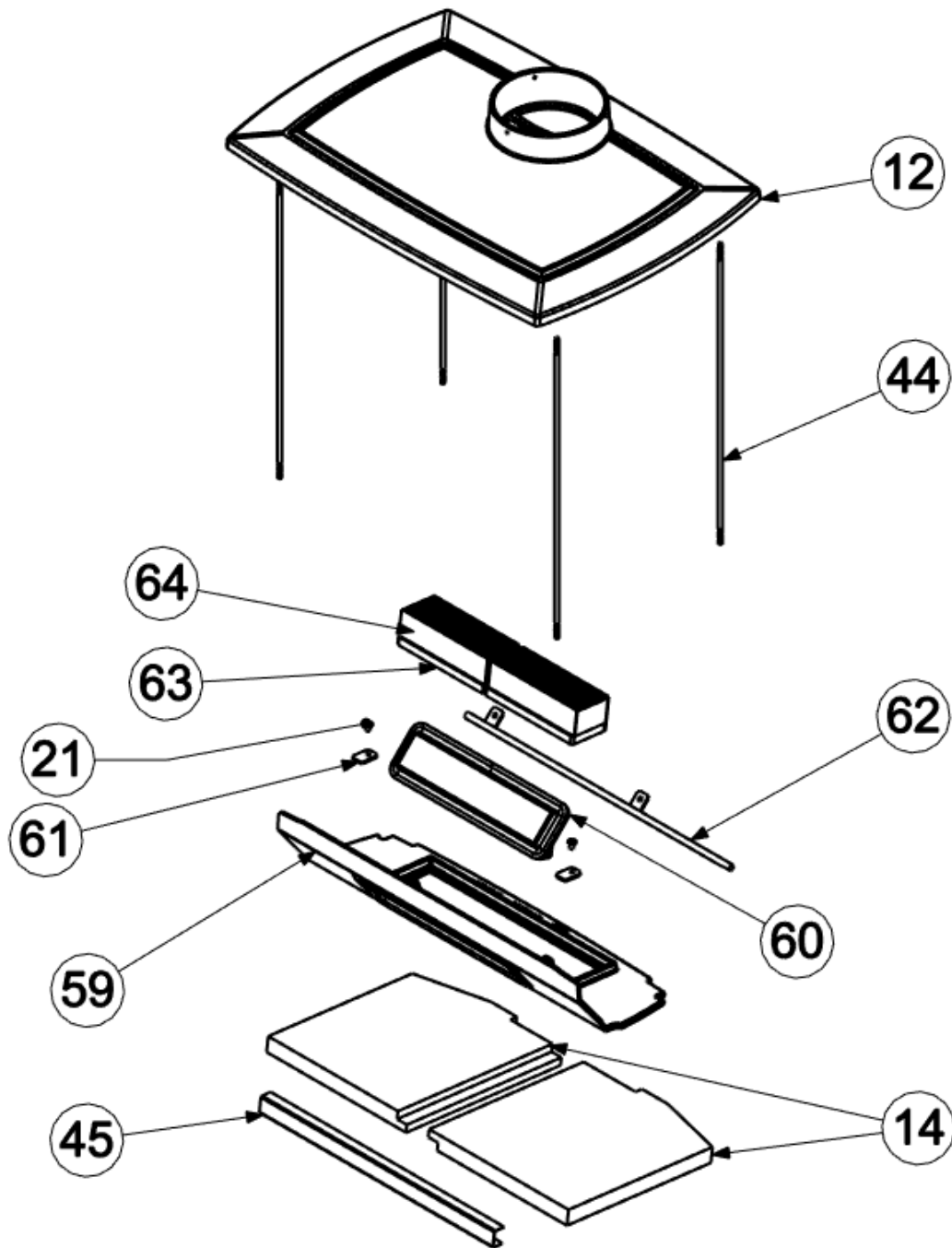

RIGHT SIDE

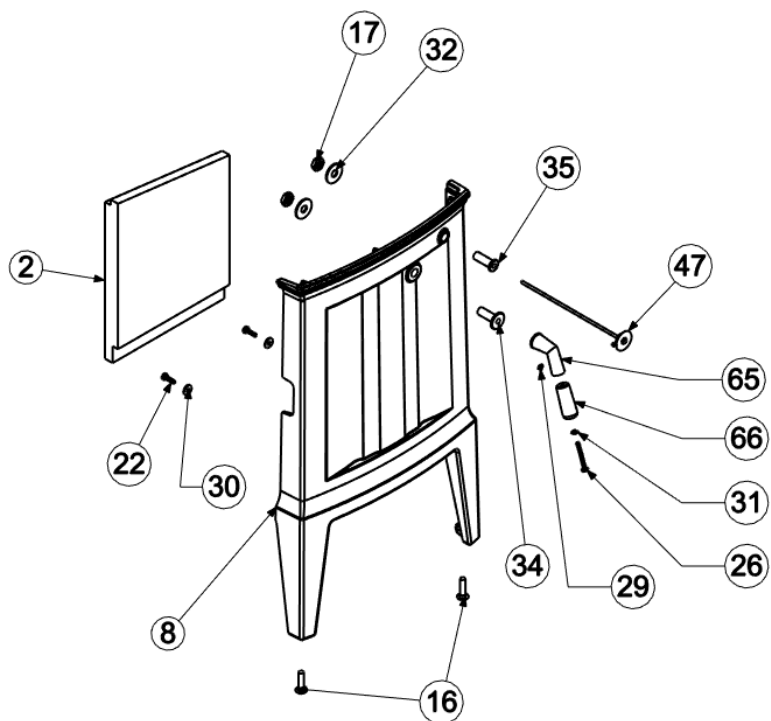

LEFT SIDE

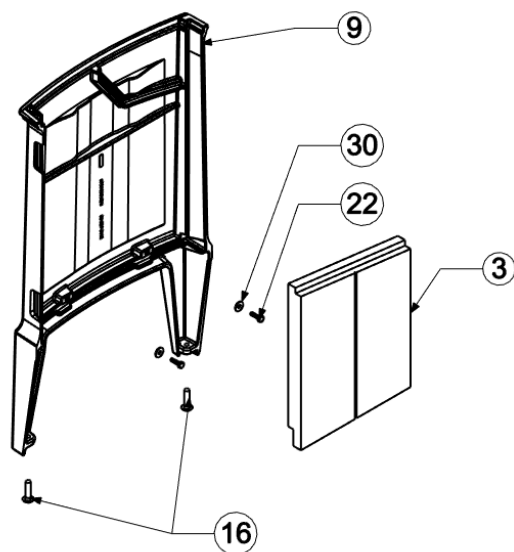

BACK

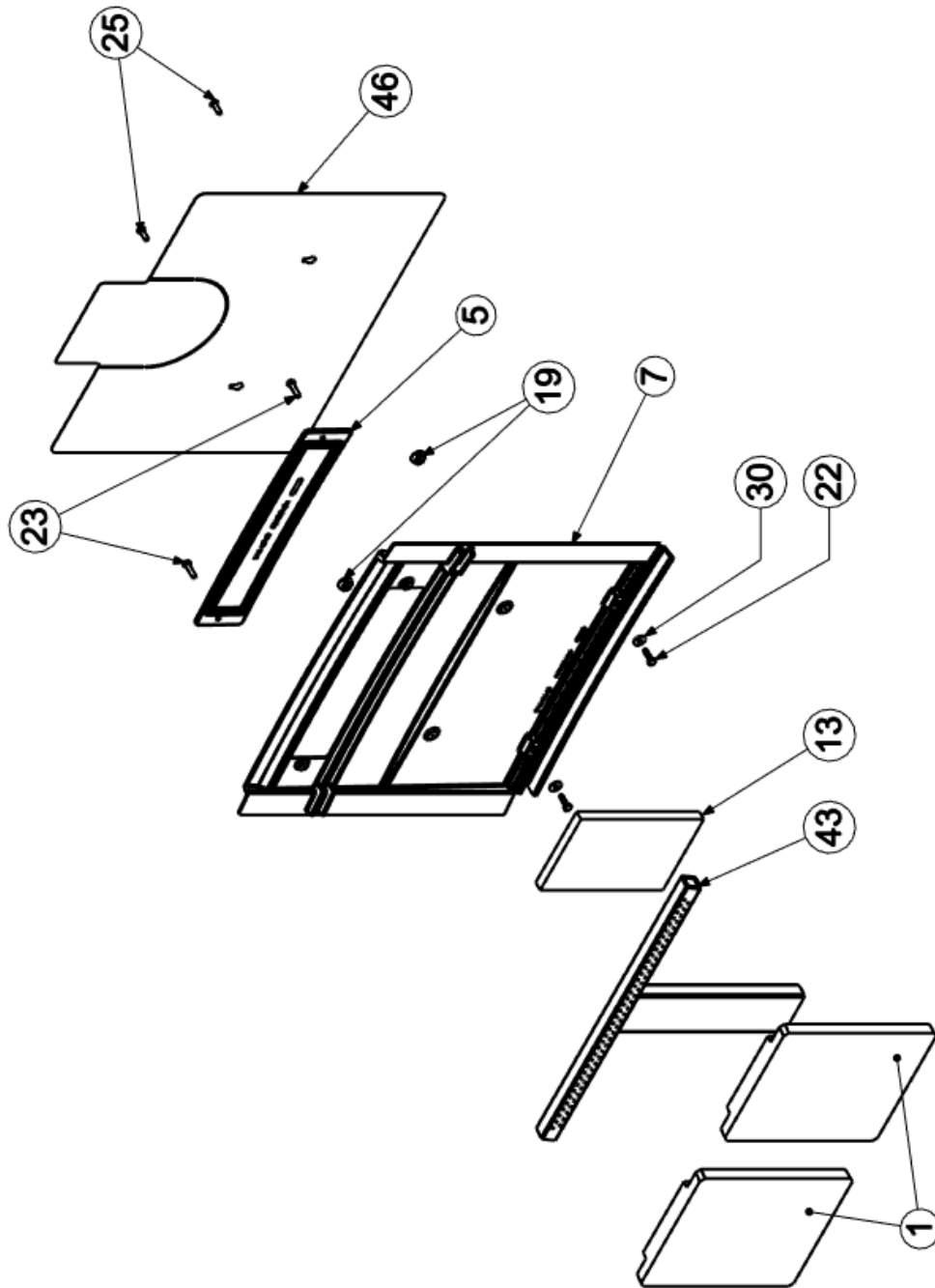

Bill of Materials

ITEM NO.	PART NUMBER	DESCRIPTION	QTY.
1	1-0600-600	REAR STONE	2
2	1-0600-601	RIGHT SIDE STONE	1
3	1-0600-602	LEFT SIDE STONE	1
4	1-0600-604	BOTTOM STONE	4
5	2610-450	Catalyst Access Cover	1
6	2610-605	BOTTOM	1
7	2610-610	BACK	1
8	2610-615	RIGHT SIDE	1
9	2610-620	LEFT SIDE	1
10	2610-625	FRONT	1
11	2610-630	PRIMARY MANIFOLD	1
12	2610-655	TOP	1
13	3070-023	REAR INSULATION	1
14	3070-025*	BAFFLE, L / R	2
15	3300-751	LABEL: SAFETY/RATING,GM60	1
16	4100-0127	BOLT: CARRIAGE,3/8-16x1-1/2	4
17	4200-0100	1/4" PIPE LOCK NUT	2
18	4200-0200	NUT: FINISHING,1/4-20,HEX,ZN	5
19	4200-0410	NUT: TAMPER-RESISTANT,3/8-16,ZN	2
20	4400-0100	RIVET: BLIND,1/8x1/4" GRIP,SS (CCP-4	3
21	4500-0540	SCREW: MACH,1/4- 20x3/8",PAN,PH,ZN,BLK	13
22	4500-0702	SCREW: CAP,1/4- 20x7/8",HEX,GRADE 5,BL OX	6
23	4500-0900	SCREW: CAP,1/4-20x1",HEX,GRADE 5	2
24	4500-1040*	SCREW: BHCS,1/4-20x1", BL OX	1
25	4500-1359	SCREW: MACH,1/4- 20x3/4",PAN,PH,BLK	2
26	4500-1377*	SCREW: MACH,1/4-20x2",PAN,PH,BL OX	2
27	4500-1510	SCREW: MACH,1/4-20x2-1/4",FLAT,PH,ZN	4
28	4500-2105	SCREW: MACH,10-24x3/8",UN- CUT,FLAT,PH,	6
29	4500-2976	SCREW: SET,5/16-18x3/8",HALF DOG,SOCKET	2

Bill of Materials

30	4600-0300	WASHER: FLAT,1/4,USS,BLK OX (3/4" OD)	10
31	4600-0400*	WASHER: LOCK, 1/4",SPLIT,ZN	7
32	4600-0880*	WASHER	2
33	5012-066	BUSHING	1
34	5031-125	BYPASS ESCUTCHEON	1
35	5031-130	PROBE ESCUTCHEON	1
36	5100-010	LABEL CLIP	2
37	5570-030	CABLE: LABEL,1/16"Dx12",2 EYES	1
38	5640-006	PIPE: LPAO	1
39	5640-008	PIN: HINGE	2
40	5640-009	HINGE BLOCK	4
41	5640-020*	STRIKER	1
42	5660-002	BOTTOM SHIELD	1
43	5660-010	SECONDARY RISER ASSY	1
44	5660-012	TIE ROD	4
45	5660-014*	GUARD, BAFFLE	1
46	5660-024	FLAT REAR SHIELD	1
47	7200-520	CAT TEMP PROBE 10"	1
48	3900-173	PRIMARY AIR KNOB	1
49	5660-004	PRIMARY AIR CONTROL	1
50	2610-635	DOOR	1
51	5240-138*	SPRING: LATCH,WOOD STOVES,325#	1
52	4600-0800*	WASHER: FLAT,5/16,USS (7/8" OD),BLK ZN	1
53	4700-0790*	SPACER: DOOR LATCH,0.435"x0.375"x0.03"	4
54	5640-022*	DOOR LATCH	1
55	3030-052*	DOOR GLASS	1
56	5370-068*	CLIP: GLASS	4
57	4500-2132	SCREW: SHCS,10-24x1/2",BL OX	10
58	3120-021*	GASKET: GLASS CLIP, BLACK	4
59	2610-640	CATALYST PLATE	1
60	2610-445	Bypass	1
61	5640-018	BYPASS RETAINER	2
62	5660-016	GM40 Bypass Rod Assy	1
63	3160-080*	GASKET, TAPE, 3/4"X 1/16", AD (1985'/SPO	2
64	3050-010*	CATALYST, 6"	2
65	5000-565*	HANDLE CRANK: BLK CHROME, EQU GM40,60,80	2

Bill of Materials

66	3900-175*	HANDLE - DOOR / BYPASS	2
----	-----------	------------------------	---

* = Available in kits only.

REPLACEMENT KITS AND ACCESSORIES

96-58400	GASKET KIT
93-58405	GLASS KIT
96-71400	HANDLE KIT
96-73400	FRONT DOOR LATCH KIT
96-75400	CATALYST REPLACEMENT KIT
96-76400	BAFFLE KIT
96-57400	BLOWER KIT

Note: See manual for accessory kits.